

江西省晶能半导体有限公司
JiangXi LatticePower Semiconductor Corporation

产 品 规 格 书
Specification

| | |
|--------------------|----------------|
| 产品名称 Product Name: | <u>LYJ</u> |
| 产品型号 Product P/N: | <u>HL</u> |
| 客 户 Client name: | <u></u> |
| 客户料号 Client P/N: | <u></u> |
| 版本号 Version No.: | <u>A04</u> |
| 日 期 Sending Date: | <u>2025.05</u> |

工厂地址:江西省南昌市高新区艾溪湖北路 699 号

Address: No.699 Aixihu North Road, Nanchang, Jiangxi Province, China

目录

Contents

| | |
|--|----|
| 1、特点 Features | 1 |
| 2、应用 Applications | 1 |
| 3、性能 Performance | 2 |
| 4、产品代码 Product Order Code | 4 |
| 5、分档规则 Bin Regulations..... | 5 |
| 6、光电特性图 The Photoelectric Characteristics Graph | 6 |
| 7、产品及焊盘尺寸 Product and Soldering Pattern Dimensions | 9 |
| 8、回流焊特性 Reflow Soldering Profile | 10 |
| 9、载带及卷轴 Tape and Reel..... | 11 |
| 10、注意事项 Cautions..... | 12 |
| 11、文件履历表 Document Resume | 13 |

1、特点 Features

- ◆ EMC 封装，高亮度，高可靠性，主要用于汽车应用
EMC package, high brightness, high reliability, it is mainly used in automotive applications
- ◆ 尺寸：2.70mm*2.00mm*0.60mm
Size: 2.70mm*2.00mm*0.60mm
- ◆ 颜色：黄色（主波长=589nm）
Color: yellow (WLD=589nm)
- ◆ 通过 ROHS 认证
RoHS compliant
- ◆ MSL 等级 2a
MSL 2a
- ◆ 通过 AEC-Q102
AEC-Q102 qualified
- ◆ 适于 SMT 贴片
Compatible with SMT
- ◆ 发光角度：120°
Viewing Angle: 120°
- ◆ 包装：最大 3000 颗/卷
Package: Max: 3000pcs /reel

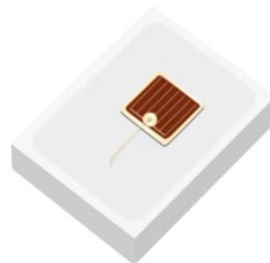

2、应用 Applications

汽车内外部照明

Interior and exterior lighting for automotive

尾灯，高位刹车灯

Stop tail Lamp, CHMSL





3、性能 Performance

a) 极限参数 Maximum Ratings

| 参数 Parameter | 符号 Symbol | 数值 Rating | 单位 Unit |
|--|--------------|--|------------|
| 最大正向电流 Max DC Forward Current | I_F | 250 | mA |
| 电功率 Electrical Power | P | 0.7 | W |
| 峰值正向电流 Peak Forward Current | I_{FP} | 500 | mA |
| 最大反向电压 Maximum Reverse Voltage | | 不可施加反向电压 Do not apply for reverse voltage | |
| 结温 (DC 模式) LED Junction Temperature (DC mode) | T_j | 150 | °C |
| 工作温度 Operating Temperature Range | T_{opr} | -40~125 | °C |
| 存储温度 Storage Temperature Range | T_{stg} | -40~125 | °C |
| ESD (人体模式) ESD(Human Body Mode) | ---- | 2000 | V |

备注 Notes :

◇ 环境温度 $T_a=25^{\circ}\text{C}$

Ratings at $T_a=25^{\circ}\text{C}$

◇ I_{FP} 脉冲时间 $\leq 10\text{ms}$, 占空比 $\leq 10\%$

I_{FP} Conditions with pulse $\leq 10\text{ms}$ and duty cycle $\leq 10\%$

b) 光电参数 Electro-Optical Characteristics (T solder pad =25 °C, I_F =200mA)

| 项目 Item | 符号 Symbol | 最小值 Min. | 典型值 Typ. | 最大值 Max. | 单位 Unit |
|--|-------------------------|-------------|-------------|-------------|------------|
| 光通量 Luminous Flux | Φ | 25.4 | 30 | 51.7 | Lm |
| 正向电压 Forward Voltage | V _F | 1.9 | 2.3 | 2.65 | V |
| 主波长 Dominant wavelength | WLD | 583 | 589 | 595 | nm |
| 反向电流 Reverse Current (V _R =5V) | I _R | -- | -- | 10 | uA |
| 实际热阻 PN/焊点 Real Thermal Resistance (Junction to Solder Point) | R _{thJS real} | | 30 | 40 | °C/W |
| 电热阻 PN/焊点 Electrical Thermal Resistance (Junction to Solder Point) | R _{thJS elec.} | | 25 | 35 | °C/W |
| 发光角度 Viewing Angle | 2θ | | 120 | | ° |

4、产品代码 Product Order Code

HL - Y2 - M9 - FG3
① ② ③ ④

- ① 产品型号 Product Type (HL:LYJ)
- ② 主波长 Dominant Wavelength
- ③ 亮度等级 Brightness Level
- ④ 电压等级 VF Level

出货标签(例) Shipping label (e.g.)



LatticePower Corporation Limited

LatticePower Item: HL-Y2-M9-FG3 LYJ

MSL 2a Reel ID: AHLA00000001

Qty: 3000 6HLXAAAA
 Date:2023-07-25

5、分档规则 Bin Regulations

a) 主波长分档 Dominant wavelength Groups (T solder pad = 25 °C, IF =200mA)

| Group Code | Min. | Max. |
|------------|------|------|
| Y1 | 583 | 586 |
| Y2 | 586 | 589 |
| Y5 | 589 | 592 |
| Y6 | 592 | 595 |

b) 亮度分档 Luminous Flux Groups (T solder pad = 25 °C, IF =200mA)

| Group Code | Min. | Max. |
|------------|------|------|
| M8 | 25.4 | 32.5 |
| M9 | 32.5 | 41.5 |
| M10 | 41.5 | 45.7 |
| M11 | 45.7 | 51.7 |

c) 电压分档 Voltage Groups (T solder pad = 25 °C, IF =200mA)

| Group Code | Min | Max |
|------------|------|------|
| FG1 | 1.90 | 2.05 |
| FG2 | 2.05 | 2.20 |
| FG3 | 2.20 | 2.35 |
| FG4 | 2.35 | 2.50 |
| FG5 | 2.50 | 2.65 |

备注 Notes :

◇ 主波长测试误差±2nm

WLD (nm) ±2nm

◇ 亮度测试存在±8%的公差

It maintains a tolerance of ±8% on luminous flux measurements.

◇ 电压测试误差±0.1V

Forward voltage(VF) ± 0.1V

6、光电特性图 The Photoelectric Characteristics Graph

Fig 1. 辐射特性 Radiation Characteristics

IF=200mA; TS = 25°C

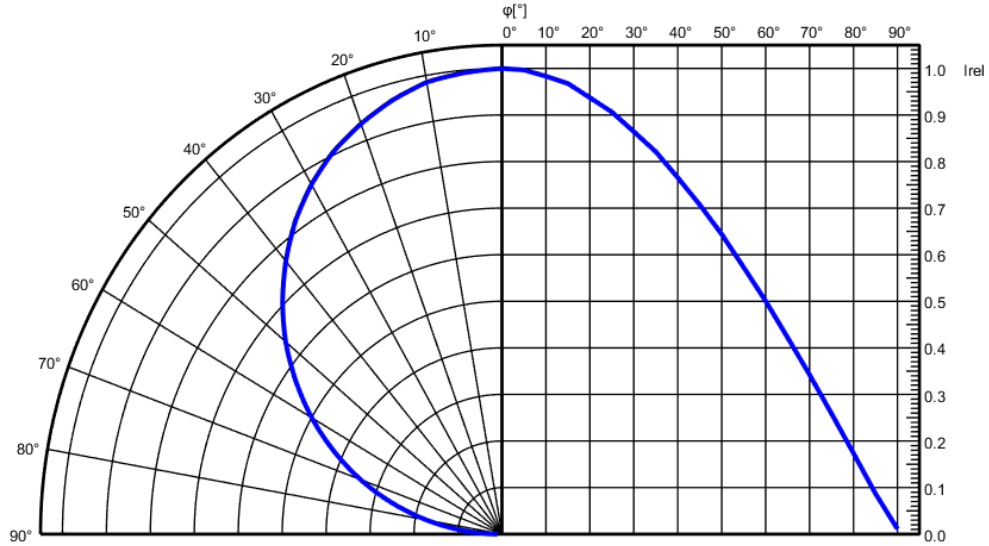

Fig 2. 相对发光光谱 Relative Spectral Power Distribution vs. Wavelength

$\Phi_{rel}=f(\lambda)$; IF=200mA; TS = 25°C

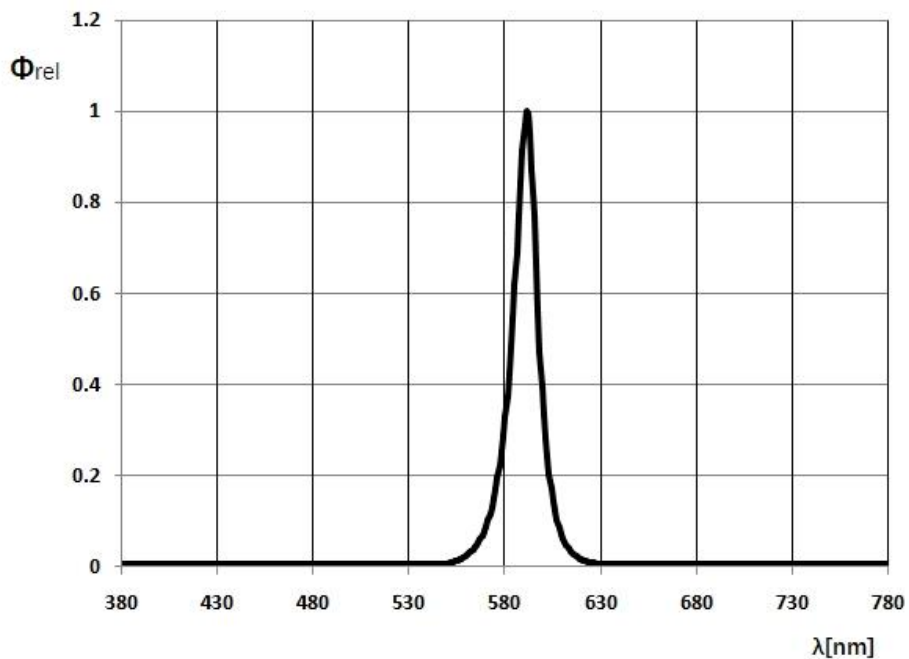



Fig 3. 正向电压 Forward Voltage

$I_F = f(V_F); TS = 25^\circ C$

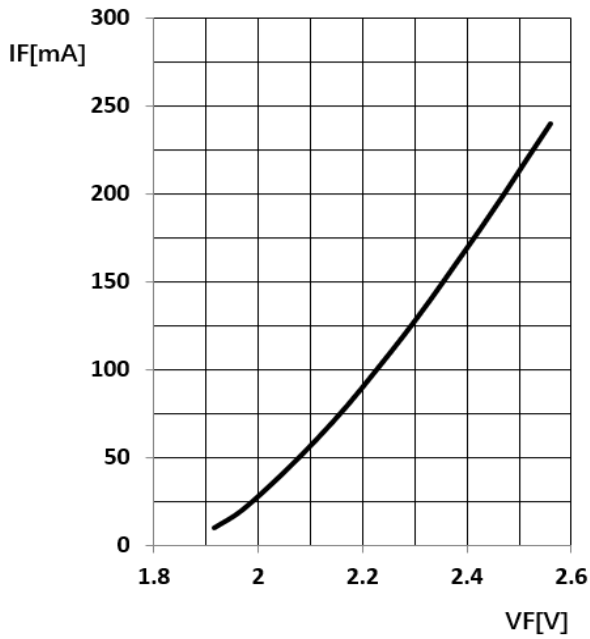

Fig 4. 相对发光强度 Relative Luminous Flux

$I_v / I_v(200 \text{ mA}) = f(I_F); TS = 25^\circ C$

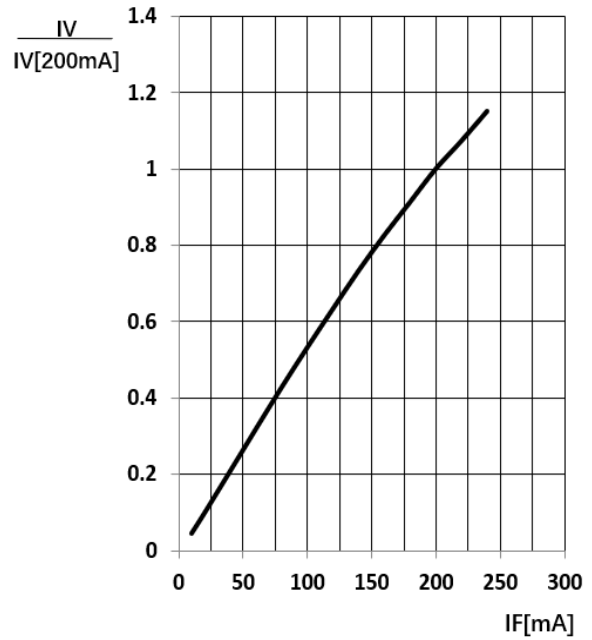

Fig 5. 波长偏移 Shift in Wavelength

$\Delta\lambda_D = f(I_F); TS = 25^\circ C$

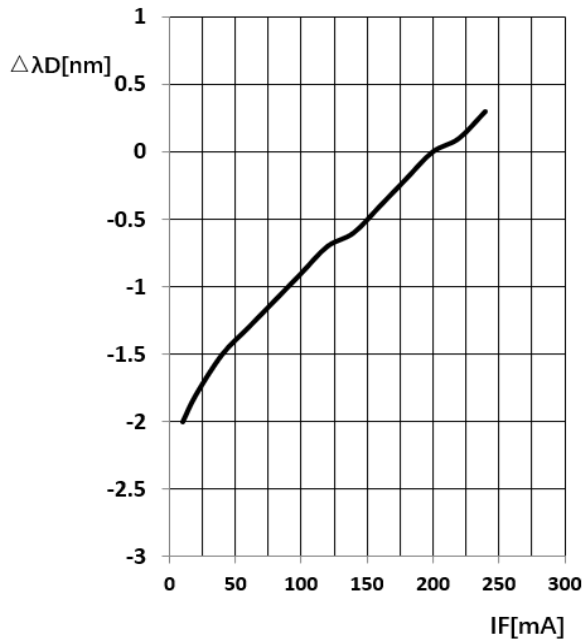



Fig 6. 正向电压 Forward Voltage

$\Delta VF = VF - VF(25^\circ C) = f(Tj); IF = 200mA$

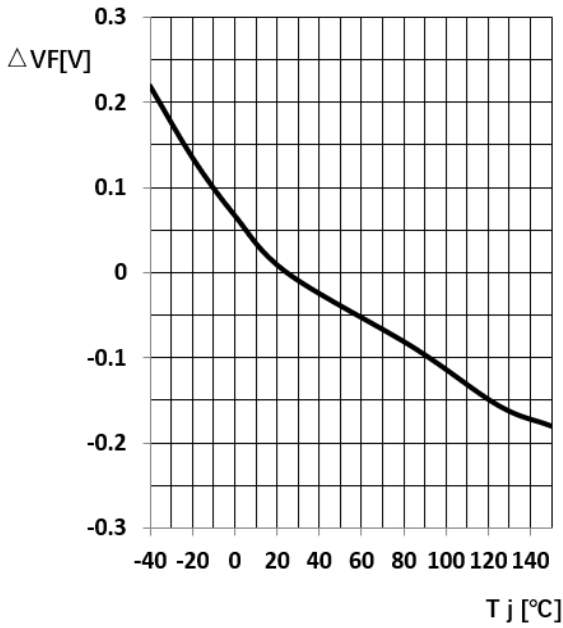

Fig 7. 相对发光强度 Relative Luminous Flux

$Iv / Iv(25^\circ C) = f(Tj); IF = 200mA$

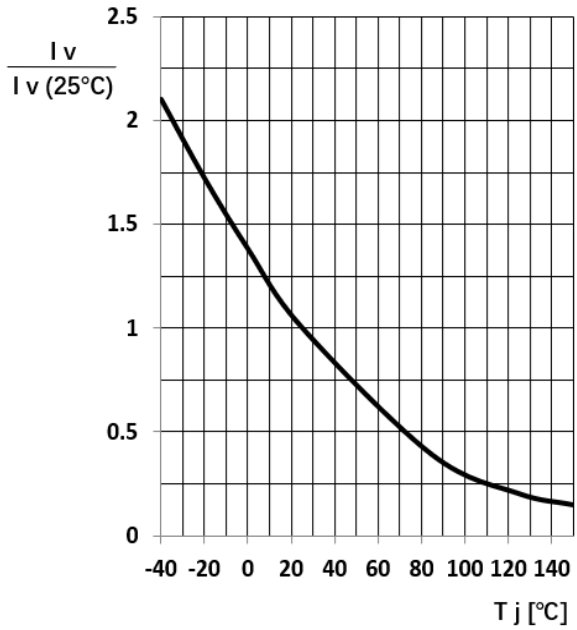

Fig 8. 波长偏移

Shift in Wavelength

$\Delta \lambda D = \lambda D - \lambda D(25^\circ C) = f(IF); TS = 25^\circ C$

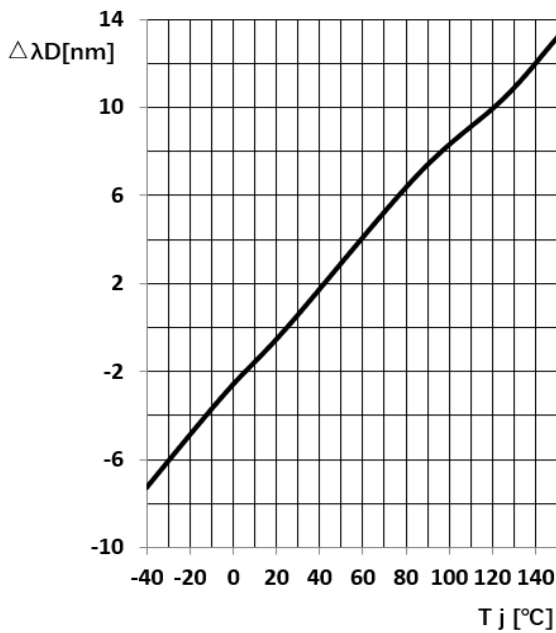
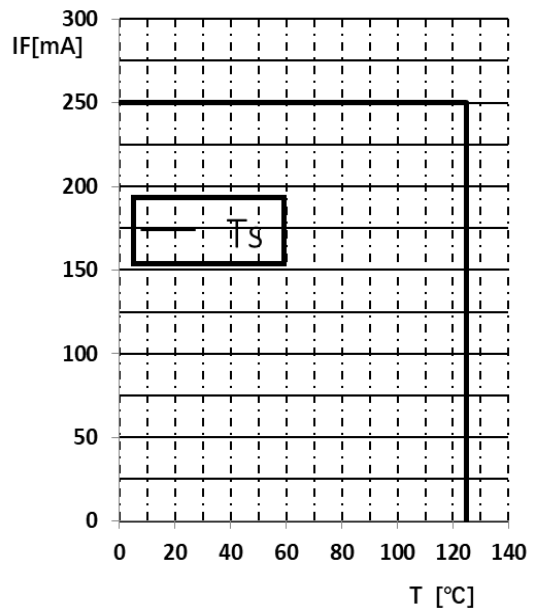

Fig 9. 最大正向电流

Max. Permissible Forward Current

$IF = f(T)$



7、产品及焊盘尺寸 Product and Soldering Pattern Dimensions

a) 产品尺寸 Product Dimensions:

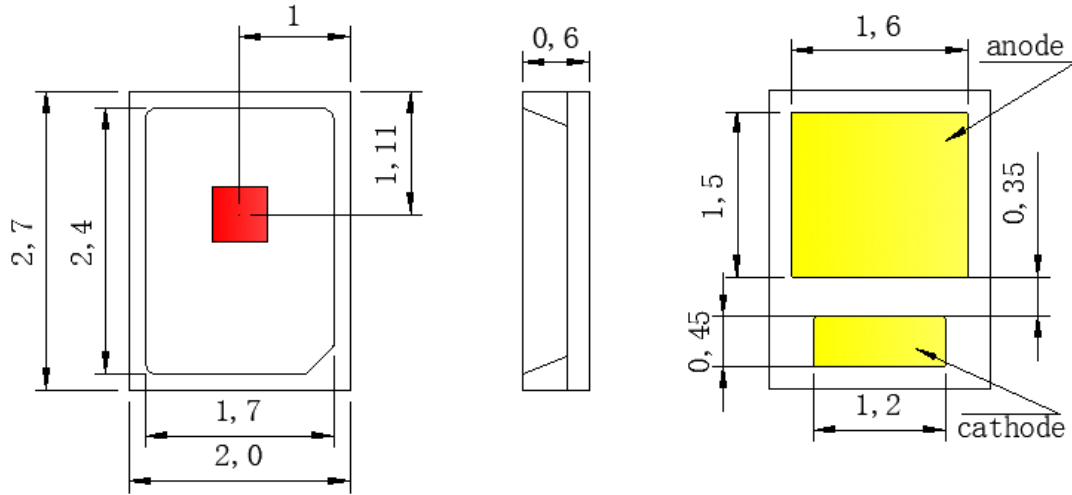

b) 焊盘尺寸 Soldering Pattern Dimensions

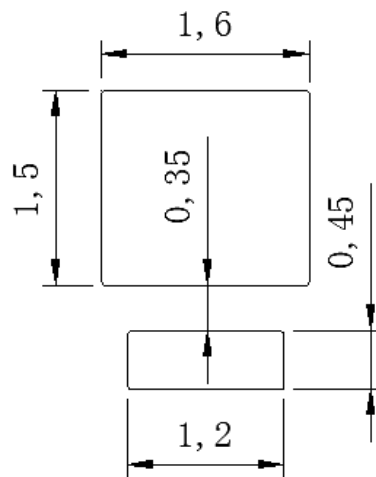

备注 Notes:

- ◇ 所有尺寸均以 mm 为单位
All dimensions are in millimeters
- ◇ 尺寸公差±0.1mm
Dimension tolerance ±0.1mm
- ◇ 灯珠近似重量: 10.0mg
Approximate Weight: 10.0mg



8、回流焊特性 Reflow Soldering Profile

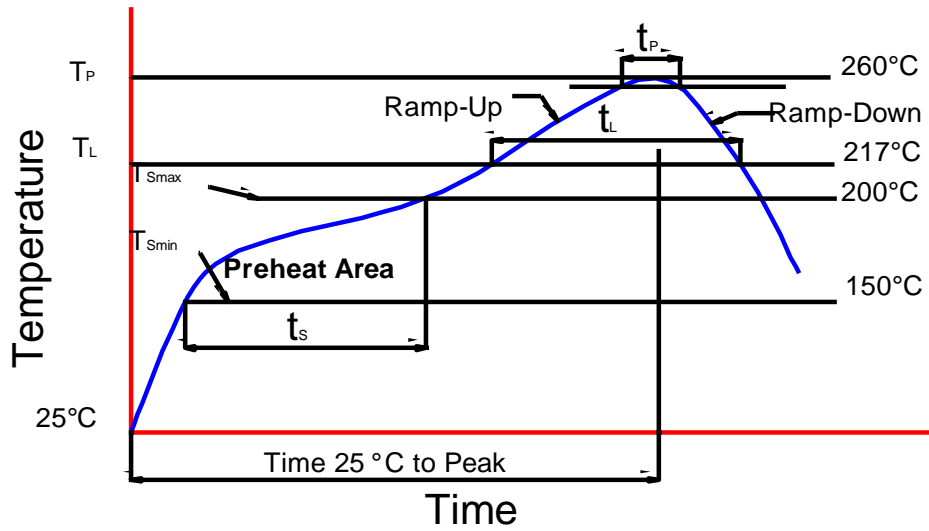

根据 EDEC-J-STD-020E 内容，参考以下内容。
Compatible with the JEDEC-J-STD-020E, using the parameters listed below.

| 特制参数 Profile Feature | 无铅焊料 Lead-Free Solder |
|---|-----------------------|
| 平均上升速率 (T _{smax} 至 T _p) Average Ramp-Up Rate (T _{smax} to T _p) | 3 °C/sec max. |
| 预热: 温度最小值 (T _{smin}) Preheat: Temperature Min (T _{smin}) | 150 |
| 预热: 最高温度 (T _{smax}) Preheat: Temperature Max (T _{smax}) | 200 |
| 预热: 时间 (t _{smin} 到 t _{smax}) Preheat: Time (t _{smin} to t _{smax}) | 60-180 secs |
| 回流温度 (T _L) Time Maintained Above: Temperature (T _L) | 217°C |
| 回流时间 (t _L) Time Maintained Above: Time (t _L) | 60-150 secs |
| 峰值/分类温度 (T _p) Peak/Classification Temperature (T _p) | 255 ± 5°C |
| 实际峰值温度 (T _p) 在 5°C 以内的时间 Time Within 5°C of Actual Peak Temperature (T _p) | 20~40 secs |
| 降低速率 Ramp-Down Rate | 4°C/sec max. |



9、载带及卷轴 Tape and Reel

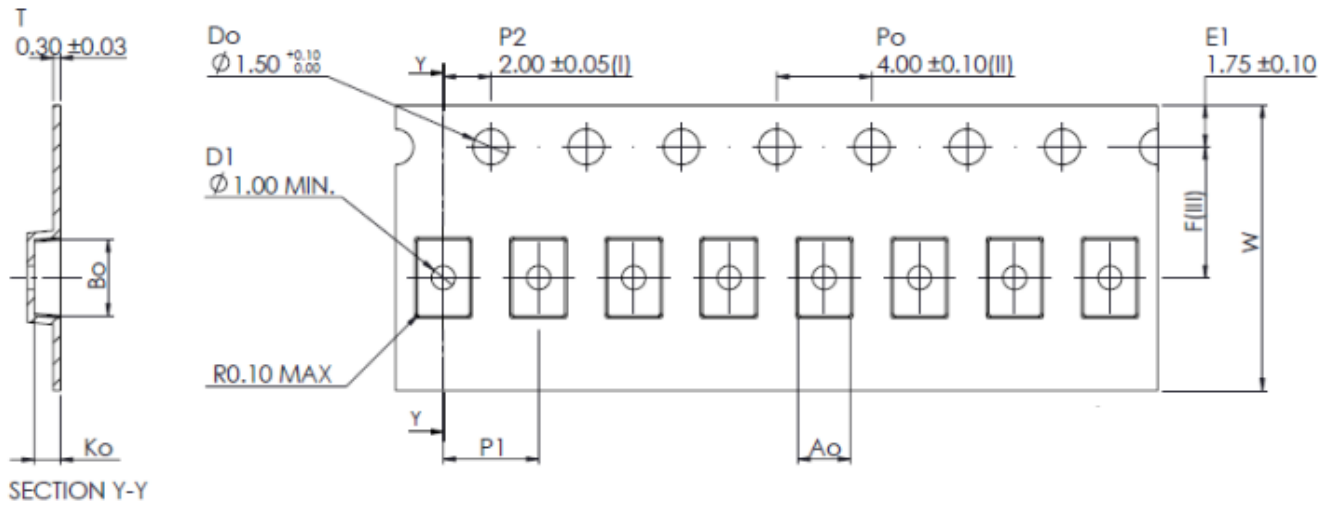

| | | |
|----|-------|--------------|
| Ao | 2.20 | +/- 0.05 |
| Bo | 3.20 | +/- 0.05 |
| Ko | 1.10 | +/- 0.05 |
| F | 5.50 | +/- 0.05 |
| P1 | 4.00 | +/- 0.10 |
| W | 12.00 | +0.30/- 0.10 |

备注 Notes:

- ◇ 卷轴包装数量: 3000pcs
Units per Reel:3000pcs
- ◇ 卷轴包装方法符合 JIS C 0806 (连续胶带上的电子元件包装)
The tape packing method complies with JIS C 0806 (Packing of Electronic Components on Continuous Tapes)
- ◇ 当卷轴由于工作中断而重绕时, 载带上压力不应超过 10N, 否则 LED 可能会粘在盖带上
When the tape is rewound due to work interruptions, no more than 10N should be applied to the embossed carrier tape
The LEDs may stick to the cover tape

10、注意事项 Cautions

a) 存储 Storage

- 即使未开封，也不要将产品放在潮湿的地方。建议存放温度在 5°C~30°C 之间，相对湿度在 30% 以下。
Even if unopened, do not store the product in a high humidity place. The recommended storage temperature is between 5°C and 30°C, and the relative humidity should be below 30%.
- 打开包装后建议在 24 小时内过完回流焊，车间条件 ≤30°C/60%RH。
It is recommended to finish the reflow soldering process within 24 hours after opening the package. The workshop conditions should be ≤30°C/60%RH.
- 本产品为 MSL 2a，如果开封后未能在期限内完成组装，再次使用前需将贴片卷盘放入 60°C 烤箱烘烤 24 小时后才能确保安全使用。建议使用后的余料可重新密封在原始真空袋中。
This product is MSL 2a. If the assembly is not completed within the specified time after opening, to ensure the quality, the tape and reel should be baked in a 60°C oven for 24 hours before reuse. It is recommended to reseal any unused material in the original vacuum bag.
- 不要接触任何未知的液体，特别是丙酮。
Do not come into contact with any unknown liquids, especially acetone.
- 防止静电损伤，手动操作需要在静电防护环境下，同时作业员需佩戴静电环。
To prevent electrostatic damage, manual operations should be performed in an electrostatic-protected environment, and operators should wear anti-static rings.

b) 操作注意 Handling Precautions

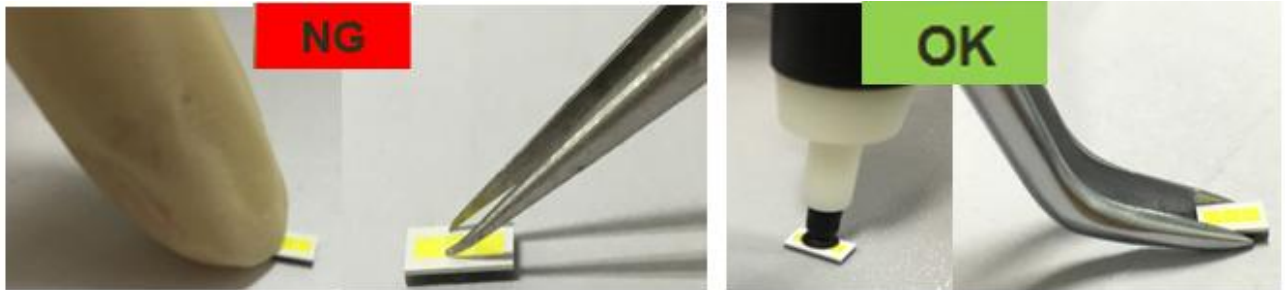

- 在处理过程中，应注意确保组件顶面不会受到压力或碰撞。
During the handling process, it is crucial to ensure that the top surface of the component is not subjected to any pressure or impact.
- 应避免使用所有类型的尖锐物体（例如镊子，指甲等），以防止对硅树脂造成压力，因为这会导致部件损坏。
The use of all types of sharp objects, such as tweezers and fingernails, should be avoided to prevent applying pressure to the silicone resin, as this can lead to component damage.

11、文件履历表 Document Resume

| 序号 | 变更日期 | 变更人 | 版本 | 变更内容 |
|----|------------|-----|-----|--|
| 01 | 2022.04.02 | 袁丁 | Y00 | 1.新制定; |
| 02 | 2022.05.23 | 袁丁 | Y01 | 1.升级参数; |
| 03 | 2022.07.04 | 袁丁 | A01 | 1.调整亮度档位, 增加一个低亮度档位 M8(25.4-32.5),减少两个高亮度档位 N2 (51.7-56.8) 和 N3 (56.8-62); |
| 04 | 2023.07.25 | 袁丁 | A02 | 1.更新公司标签抬头; |
| 05 | 2024.3.09 | 李俊杰 | A03 | 1.删除最小正向电流信息; 2.新增灯珠质量信息; |
| 06 | 2025.05.22 | 曾海强 | A04 | 1.更新文档文字及格式; 2.更新降额曲线 |
| | | | | |
| | | | | |
| | | | | |
| | | | | |
| | | | | |