



江西省晶能半导体有限公司

JiangXi LatticePower Semiconductor Corporation

产 品 规 格 书 Specification

产品名称 Product Name: TH

产品型号 Product P/N: TG3

客 户 Client name: _____

客户料号 Client P/N: _____

版 本 号 Version No.: A04

日 期 Sending Date: 2023.12.26

客户承认栏 Client Approval	
核准 Approval	确认 Audit

制定 Confirmation: _____ 审核 Approval: _____

工厂地址:江西省南昌市高新区艾溪湖北路 699 号

Address: No.699 Aixihu North Road, Nanchang, Jiangxi Province, China

目录

Contents

1、特点 Features.....	1
2、应用 Applications.....	1
3、性能 Performance	2
4、产品代码 Product Order Code	3
5、分档规则 Bin Regulations	10
6、光电特性图 The Photoelectric Characteristics Graph.....	15
7、产品及钢网尺寸 Product and PCB Pad Dimensions.....	17
8、回流焊特性 Reflow Soldering Characteristics	18
9、卷轴 Reel Dimensions.....	19
10、可靠性验证 Reliability.....	20
11、注意事项 Cautions	21

1、特点 Features

- ◆ 陶瓷封装, 高亮度, 高光效
Ceramic Substrate package , High brightness ,High efficiency
- ◆ 尺寸: 3.45mm*3.45mm
Size: 3.45mm*3.45mm
- ◆ 根据 ANSI 标准分档
According to the ANSI standard colour gamut
- ◆ 700mA@85°C分档
Binned at 700mA@85°C
- ◆ 适于 SMT 贴片
Compatible with SMT
- ◆ 发光角度: 120°
Viewing Angle: 120°
- ◆ 亮度典型值: Typ.365lm @5700K @Tj85°C
Luminous Flux: Typ.365lm @5700K @ Tj 85°C
- ◆ 光效典型值: Typ.185lm/W @5700K @ Tj 85°C
Luminous efficacy: Typ.185lm/W @5700K @ Tj 85°C
- ◆ 包装: 最大 1000 颗/卷
Package: Max: 1000pcs /reel



2、应用 Applications

建筑照明	Architectural
工业照明	Industrial
商业照明	Commercial
室内外照明	Indoor and outdoor area





3、性能 Performance

a) 绝对最大额定值 Absolute Maximum Ratings

参数 Parameter	符号 Symbol	最大参数值 Maximum Rating	单位 Unit
电流 Forward Current	I_F	2000	mA
工作温度 Operating Temperature	T_{opr}	-40~105	°C
存储温度 Storage Temperature	T_{stg}	-40~125	°C
ESD Classification(HBM)	-	8	kV
结温 Junction Temperature	T_j	150	°C

b) 光电参数 Electro-Optical Characteristics ($I_F=700mA, @ T_j 85^\circ C$)

项目 Item	符号 Symbol	最小值 Min.	典型值 Typ.	最大值 Max.	单位 Unit
光通量 Luminous Flux	Φ	Refer to Flux Rank Distribution			Lm
正向电压 Forward Voltage	VF	2.7	2.8	3.1	V
热阻 Thermal Resistance	----	----	3.0	----	°C/W
发光角度 Viewing Angle	2 θ 1/2	----	120	----	°

4、产品代码 Product Order Code

TG - C7 - Q - H2 - D
 ① ② ③ ④ ⑤





- ① 产品型号 Product Type
- ② 显色指数 Ra level
- ③ 色温 CCT
- ④ 亮度 Luminous
- ⑤ 电压 Forward Voltage

a) 出货标签(例) Shipping label (e.g.)



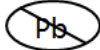

 LatticePower

LatticePower Corporation Limited
 Part No: TG-C7-Q-H2-D

ROHS
MSL3



 Item: TG-C-Q2-RB-DB8

 Reel ID: ATHC00016212

 Date: 20230420

~~Pls~~

 Qty: 1000

 6HTABCA

 COO: CN



b) Part No.信息 Part No. Information

Digit	PKG Information	Code	Specification						
1	Product	TG	TG						
2	CRI	00	L1	无要求					
		C7	C	min70					
		75	D	min75					
		C8	E	min80					
		C9	G	min90					
		95	H	min95					
3	CCT(K)	A	Amber	L1	PA1、PA2				
		H	7000	C	ZA、ZB、ZC、ZD				
		P	6500	C、D	1A、1B、1C、1D、P1、P2、P3、P4				
		Q	5700	C、D	2A、2B、2C、2D、Q1、Q2、Q3、Q4				
		R	5000	C、D	3A、3B、3C、3D、R1、R2、R3、R4				
		X	4500	C、D	4A、4B、4C、4D、S1、S2、S3、S4				
		T	4000	C、D	5A、5B、5C、5D、T1、T2、T3、T4				
		U	3500	C、D	6A、6B、6C、6D、U1、U2、U3、U4				
		V	3000	C、D	7A、7B、7C、7D、7A3、7B4、7C1、7D2、V1、V2、V3、V4				
		W	2700	C、D	8A、8B、8C、8D、W1、W2、W3、W4				
		P	6500	E、G、H	2A、3A、A1、A2、AE、AF、AG、AH、AA、AB、AC、AD				
		Q	5700	E、G、H	2B、3B、B1、B2、BE、BF、BG、BH、BA、BB、BC、BD				
		R	5000	E、G、H	2C、3C、C1、C2、CE、CF、CG、CH、CA、CB、CC、CD				
		S	4500	E、G、H	2D、3D、D1、D2、DE、DF、DG、DH、DA、DB、DC、DD				
		T	4000	E、G、H	2E、3E、E1、E2、EE、EF、EG、EH、EA、EB、EC、ED				
		U	3500	E、G、H	2F、3F、F1、F2、FE、FF、FG、FH、FA、FB、FC、FD				
		V	3000	E、G、H	2G、3G、G1、G2、GE、GF、GG、GH、GA、GB、GC、GD				
		W	2700	E、G、H	2H、3H、H1、H2、HE、HF、HG、HH、HA、HB、HC、HD				
		4	Luminous (lm)	A2	150-170	N1,P1	N1	150	160
							P1	160	170
B2	170-190			Q1,R1	Q1	170	180		
					R1	180	190		
C2	190-210			S1,V1	S1	190	200		
					V1	200	210		
D2	210-230			W1,Y1	W1	210	220		
					Y1	220	230		
E2	190-230			HB,JB	HB	190	210		
					JB	210	230		



4	Luminous (lm)	F2	230-270	KB,MB	KB	230	250
					MB	250	270
		G2	270-310	NB,PB	NB	270	290
					PB	290	310
		H2	310-350	QB,RB	QB	310	330
					RB	330	350
		J2	350-390	SB,TB	SB	350	370
					TB	370	390
		K2	380-420	U6,V2	U6	380	400
					V2	400	420
		L2	420-460	V3,V4	V3	420	440
					V4	440	460
		M2	460-500	V5,V6	V5	460	480
					V6	480	500
		N2	500-550	V7,V8	V7	500	520
					V8	520	550
P2	550-610	V21 V22	V21	550	580		
			V22	580	610		
5	Forward Voltage(V)	D	2.5-3.1	DB6	2.5	2.7	
				DB7	2.7	2.9	
				DB8	2.9	3.1	

c) 亮度分档 Luminous Flux Binning (IF=700mA,@ Tj 85°C)

Bin	symbol	Min.	Max.	Unit
HB	IV	190	210	lm
JB	IV	210	230	
KB	IV	230	250	
MB	IV	250	270	
NB	IV	270	290	
PB	IV	290	310	
QB	IV	310	330	
RB	IV	330	350	
SB	IV	350	370	
TB	IV	370	390	

备注 Notes :

◇ 光通量测量误差范围±7%

Luminous flux measurement tolerance: ±7%



❖ 光通量特性

Luminous Flux Characteristics

CCT	CRI		Condition		Flux
	Typ.@700mA		IF(mA)	Tj(°C)	Typ.
3000	70		350	25	200
			350	85	181
			700	85	335
			1000	85	455
			1200	85	527
3000	80		350	25	184
			350	85	165
			700	85	309
			1000	85	420
			1200	85	488
4000	70		350	25	210
			350	85	188
			700	85	351
			1000	85	476
			1200	85	552
4000	80		350	25	194
			350	85	174
			700	85	327
			1000	85	445
			1200	85	517
5000	70		350	25	210
			350	85	189
			700	85	351
			1000	85	475
			1200	85	551
5700	70		350	25	204
			350	85	184
			700	85	341
			1000	85	461
			1200	85	536



❖ 光通量特性

Luminous Flux Characteristics

CCT	CRI	Condition		Flux
	Typ.@700mA	IF(mA)	Tj(°C)	Typ.
5700	80	350	25	210
		350	85	187
		700	85	350
		1000	85	473
		1200	85	549
6500	70	350	25	200
		350	85	179
		700	85	335
		1000	85	455
		1200	85	516



d) 电压分档 Forward Voltage Binning (IF =700mA,@ Tj 85°C)

Bin	symbol	Min.	Max.	Unit
DB6	VF	2.5	2.7	V
DB7	VF	2.7	2.9	
DB8	VF	2.9	3.1	

备注 Notes :

◇ 电压测量误差范围±0.06V

Tolerance is ±0.06V on voltage measurements

e) 显指分档 Ra Groups

Bin	symbol	Min.	Max.	R9
L1	CRI	0	100	/
C	CRI	70	80	/
D	CRI	75	85	/
E	CRI	80	90	Min.0
G	CRI	90	100	Min.50
H	CRI	95	100	Min.75

备注 Notes :

◇ 显指测量误差范围±2

Tolerance is ±2 on CRI measurements



f) 亮度分布 Flux Rank Distribution (IF =700mA,@ Tj 85°C)

CRI 70

■ 供货等级 Available Rank

CCT	CIE	CRI	Flux Rank								
7500	Z	70	JB	KB	MB	NB	PB	QB	RB	SB	TB
6500	P	70	JB	KB	MB	NB	PB	QB	RB	SB	TB
5700	Q	70	JB	KB	MB	NB	PB	QB	RB	SB	TB
5000	R	70	JB	KB	MB	NB	PB	QB	RB	SB	TB
4000	T	70	JB	KB	MB	NB	PB	QB	RB	SB	TB
3500	U	70	JB	KB	MB	NB	PB	QB	RB	SB	TB
3000	V	70	JB	KB	MB	NB	PB	QB	RB	SB	TB
2700	W	70	JB	KB	MB	NB	PB	QB	RB	SB	TB

CRI 80

■ 供货等级 Available Rank

CCT	CIE	CRI	Flux Rank								
6500	A	80	JB	KB	MB	NB	PB	QB	RB	SB	TB
5700	B	80	JB	KB	MB	NB	PB	QB	RB	SB	TB
5000	C	80	JB	KB	MB	NB	PB	QB	RB	SB	TB
4000	E	80	JB	KB	MB	NB	PB	QB	RB	SB	TB
3500	F	80	JB	KB	MB	NB	PB	QB	RB	SB	TB
3000	G	80	JB	KB	MB	NB	PB	QB	RB	SB	TB
2700	H	80	JB	KB	MB	NB	PB	QB	RB	SB	TB

CRI 90/95

■ 供货等级 Available Rank

CCT	CIE	CRI	Flux Rank								
5700	B	90	JB	KB	MB	NB	PB	QB	RB	SB	TB
5700	B	95	JB	KB	MB	NB	PB	QB	RB	SB	TB
4500	D	95	JB	KB	MB	NB	PB	QB	RB	SB	TB

5、色区分档规则 Color Bin Regulations

a) 色区图 CIE Chromaticity Diagram

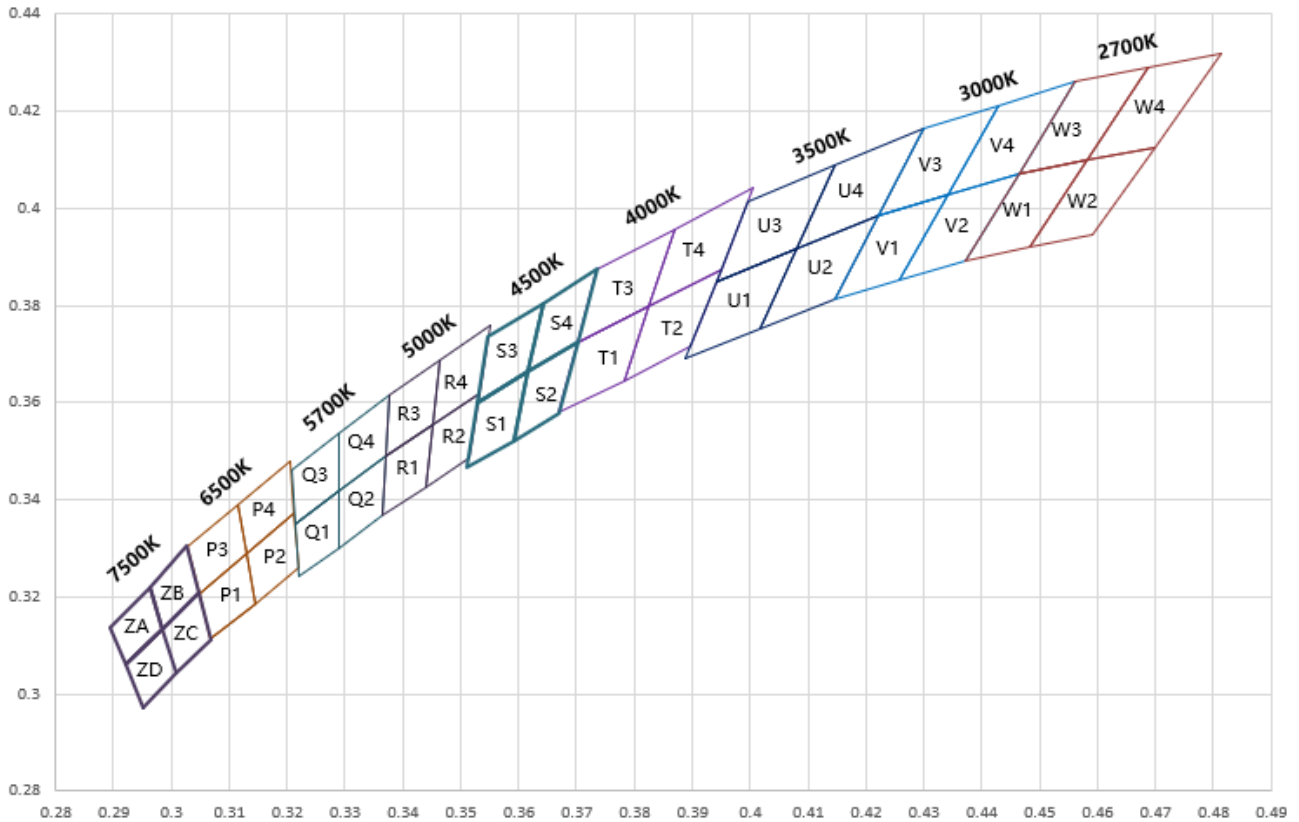

b) 金黄光色区图 CIE Chromaticity Diagram (Amber)

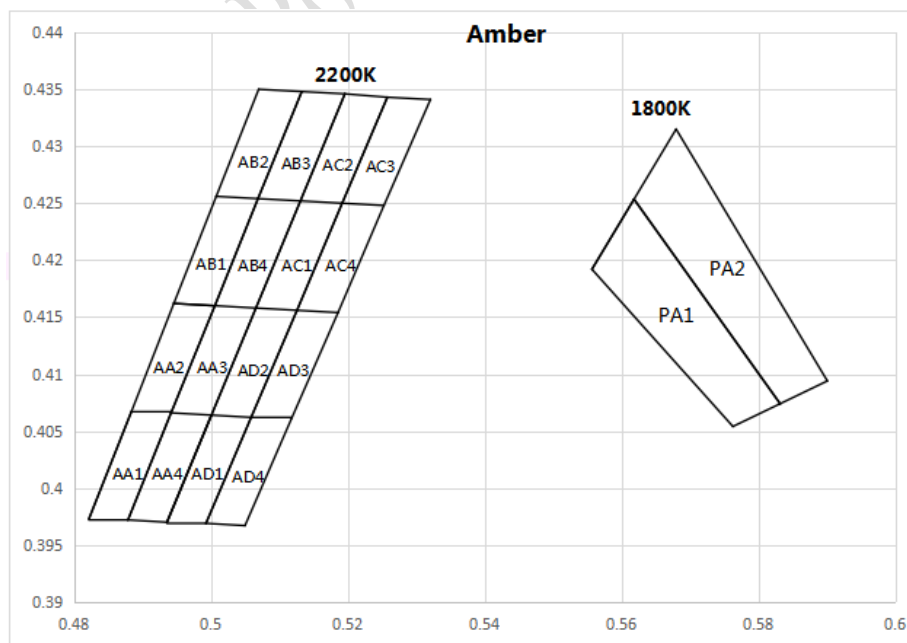



c) ANSI Bin 定义 ANSI Color bin definitions

色区	X	Y	色区	X	Y	色区	X	Y	色区	X	Y
P1	0.3068	0.3113	P2	0.3144	0.3186	P3	0.3048	0.3207	P4	0.3130	0.3290
	0.3144	0.3186		0.3221	0.3261		0.3130	0.3290		0.3213	0.3373
	0.3130	0.3290		0.3213	0.3373		0.3115	0.3391		0.3205	0.3481
	0.3048	0.3207		0.313	0.329		0.3028	0.3304		0.3115	0.3391
Q1	0.3215	0.3350	Q2	0.3290	0.3417	Q3	0.3207	0.3462	Q4	0.3290	0.3538
	0.329	0.3417		0.3371	0.349		0.329	0.3538		0.3376	0.3616
	0.329	0.33		0.3366	0.3369		0.329	0.3417		0.3371	0.349
	0.3222	0.3243		0.3290	0.3300		0.3215	0.3350		0.3290	0.3417
R1	0.3371	0.3490	R2	0.3451	0.3554	R3	0.3376	0.3616	R4	0.3463	0.3687
	0.3451	0.3554		0.3533	0.362		0.3463	0.3687		0.3551	0.376
	0.344	0.3427		0.3515	0.3487		0.3451	0.3554		0.3533	0.362
	0.3366	0.3369		0.3440	0.3427		0.3371	0.3490		0.3451	0.3554
S1	0.3530	0.3601	S2	0.3617	0.3663	S3	0.3642	0.3805	S4	0.3642	0.3805
	0.3617	0.3663		0.3703	0.3726		0.3617	0.3663		0.3736	0.3874
	0.3591	0.3522		0.367	0.3578		0.353	0.3601		0.3703	0.3726
	0.3512	0.3465		0.3591	0.3522		0.3548	0.3736		0.3617	0.3663
T1	0.3702	0.3722	T2	0.3825	0.3798	T3	0.3736	0.3874	T4	0.3869	0.3958
	0.3825	0.3798		0.3950	0.3875		0.3869	0.3958		0.4006	0.4044
	0.3783	0.3646		0.3898	0.3716		0.3825	0.3798		0.3950	0.3875
	0.367	0.3578		0.3783	0.3646		0.3702	0.3722		0.3825	0.3798
U1	0.3941	0.3848	U2	0.408	0.3916	U3	0.3996	0.4015	U4	0.4146	0.4089
	0.4080	0.3916		0.4221	0.3984		0.4146	0.4089		0.4299	0.4165
	0.4017	0.3751		0.4147	0.3814		0.4080	0.3916		0.4221	0.3984
	0.3889	0.369		0.4017	0.3751		0.3941	0.3848		0.4080	0.3916
V1	0.4221	0.3984	V2	0.4342	0.4028	V3	0.4299	0.4165	V4	0.4430	0.4212
	0.4342	0.4028		0.4465	0.4071		0.443	0.4212		0.4562	0.426
	0.4259	0.3853		0.4373	0.3893		0.4342	0.4028		0.4465	0.4071
	0.4147	0.3814		0.4259	0.3853		0.4221	0.3984		0.4342	0.4028
W1	0.4465	0.4071	W2	0.4582	0.4099	W3	0.4562	0.426	W4	0.4687	0.4289
	0.4582	0.4099		0.4700	0.4126		0.4687	0.4289		0.4813	0.4319
	0.4483	0.3919		0.4593	0.3944		0.4582	0.4099		0.4700	0.4126
	0.4373	0.3893		0.4483	0.3919		0.4465	0.4071		0.4582	0.4099



色区	X	Y	色区	X	Y	色区	X	Y	色区	X	Y
AA1	0.4822	0.3973	AA2	0.4884	0.4067	AA3	0.4942	0.4066	AA4	0.4879	0.3972
	0.4884	0.4067		0.4946	0.4162		0.5006	0.416		0.4942	0.4066
	0.4942	0.4066		0.5006	0.416		0.5066	0.4158		0.5001	0.4064
	0.4879	0.3972		0.4942	0.4066		0.5001	0.4064		0.4936	0.397
AB1	0.4946	0.4162	AB2	0.5008	0.4256	AB3	0.5069	0.4254	AB4	0.5006	0.416
	0.5008	0.4256		0.507	0.435		0.5133	0.4348		0.5069	0.4254
	0.5069	0.4254		0.5133	0.4348		0.5196	0.4346		0.5131	0.4252
	0.5006	0.416		0.5069	0.4254		0.5131	0.4252		0.5066	0.4158
AC1	0.5066	0.4158	AC2	0.5131	0.4252	AC3	0.5192	0.425	AC4	0.5126	0.4156
	0.5131	0.4252		0.5196	0.4346		0.5258	0.4343		0.5192	0.425
	0.5192	0.425		0.5258	0.4343		0.5321	0.4341		0.5253	0.4248
	0.5126	0.4156		0.5192	0.425		0.5253	0.4248		0.5186	0.4154
AD1	0.4936	0.397	AD2	0.5001	0.4064	AD3	0.5059	0.4062	AD4	0.4993	0.3969
	0.5001	0.4064		0.5066	0.4158		0.5126	0.4156		0.5059	0.4062
	0.5059	0.4062		0.5126	0.4156		0.5186	0.4154		0.5118	0.4061
	0.4993	0.3969		0.5059	0.4062		0.5118	0.4061		0.505	0.3967
PA1	0.5557	0.4192	PA2	0.56185	0.42535						
	0.56185	0.42535		0.568	0.4315						
	0.5832	0.4074		0.5901	0.4094						
	0.5763	0.4054		0.5832	0.4074						
ZA	0.292	0.306	ZB	0.2984	0.3133	ZC	0.2984	0.3133	ZD	0.295	0.297
	0.2895	0.3135		0.2962	0.322		0.3048	0.3207		0.292	0.306
	0.2962	0.322		0.3028	0.3304		0.3068	0.3113		0.2984	0.3133
	0.2984	0.3133		0.3048	0.3207		0.3009	0.3042		0.3009	0.3042

备注 Notes :

- ◇ 色度坐标 (x, y) 来自 CIE1931 色度图
The chromaticity coordinates(x,y)is derived from the CIE 1931 chromaticity diagram
- ◇ 测试分选设备用于光通量 (lm) 和 CIE1931 色度坐标 (x, y) 测试。
Testing&Sorting Machine is for the luminous flux(lm) and the CIE1931 chromaticity coordinates(x,y) testing.
- ◇ 色度坐标 (x, y) 存在±0.006 公差。
The chromaticity coordinates(x,y) guarantee should be added ±0.006 tolerance.

d) 色区图 CIE Chromaticity Diagram

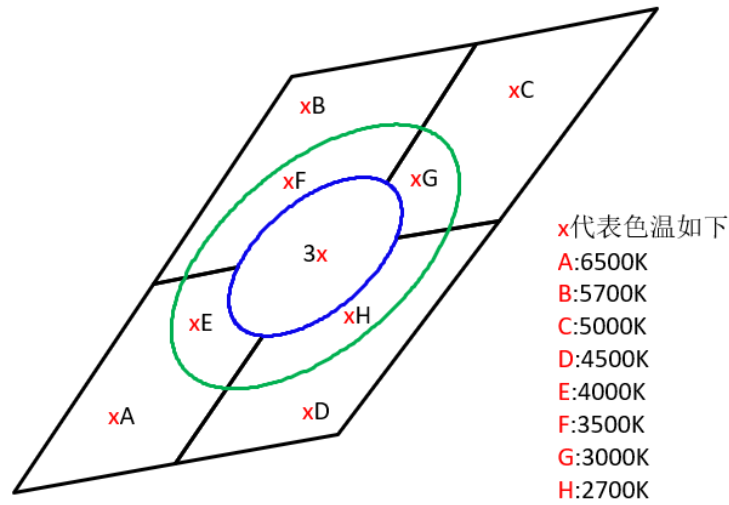

e) 麦克亚当椭圆 Bin 定义 MacAdam ellipse color bin definitions

CCT	COLOR SPACE	center		major axis (a)	minor axis (b)	rotation (deg)
		x0	y0			
2700K	3-step	0.4578	0.4101	0.0081	0.0042	53.70
	5-step			0.0135	0.007	
3000K	3-step	0.4338	0.4030	0.00834	0.00408	53.22
	5-step			0.0139	0.0068	
3500K	3-step	0.4073	0.3917	0.00927	0.00414	54.00
	5-step			0.01545	0.0069	
4000K	3-step	0.3818	0.3797	0.00939	0.00402	53.72
	5-step			0.01565	0.0067	
4500K	3-step	0.3611	0.3658	0.00756	0.003375	57.58
	5-step			0.0126	0.005625	
5000K	3-step	0.3447	0.3553	0.00822	0.00354	59.62
	5-step			0.0137	0.0059	
5700K	3-step	0.3287	0.3417	0.007455	0.003195	59.09
	5-step			0.012425	0.005325	
6500K	3-step	0.3123	0.3282	0.00669	0.00285	58.57
	5-step			0.01115	0.00475	

f) ANSI Bin 定义 ANSI Color bin definitions

色区	X	Y	色区	X	Y	色区	X	Y	色区	X	Y
AA	0.3048	0.3207	BA	0.3215	0.335	CA	0.3371	0.349	DA	0.3530	0.3597
	0.3130	0.3290		0.3290	0.3417		0.3451	0.3554		0.3615	0.3659
	0.3144	0.3186		0.3290	0.3300		0.3440	0.3427		0.3590	0.3521
	0.3068	0.3113		0.3222	0.3243		0.3366	0.3369		0.3512	0.3465
AB	0.3028	0.3304	BB	0.3207	0.3462	CB	0.3376	0.3616	DB	0.3548	0.3736
	0.3115	0.3391		0.329	0.3538		0.3463	0.3687		0.3641	0.3804
	0.313	0.329		0.329	0.3417		0.3451	0.3554		0.3615	0.3659
	0.3048	0.3207		0.3215	0.3350		0.3371	0.3490		0.3530	0.3597
AC	0.3115	0.3391	BC	0.3290	0.3538	CC	0.3463	0.3687	DC	0.3641	0.3804
	0.3205	0.3481		0.3376	0.3616		0.3551	0.376		0.3736	0.3874
	0.3213	0.3373		0.3371	0.349		0.3533	0.362		0.3702	0.3722
	0.3130	0.3290		0.3290	0.3417		0.3451	0.3554		0.3615	0.3659
AD	0.313	0.329	BD	0.329	0.3417	CD	0.3451	0.3554	DD	0.3615	0.3659
	0.3213	0.3373		0.3371	0.3490		0.3533	0.3620		0.3702	0.3722
	0.3221	0.3261		0.3366	0.3369		0.3515	0.3487		0.3670	0.3578
	0.3144	0.3186		0.329	0.33		0.344	0.3427		0.359	0.3521
EA	0.367	0.3578	FA	0.3889	0.369	GA	0.4147	0.3814	HA	0.4373	0.3893
	0.3698	0.3703		0.3941	0.3848		0.4221	0.3985		0.4467	0.4076
	0.3819	0.3777		0.4081	0.3918		0.4343	0.4030		0.4585	0.4102
	0.3783	0.3646		0.4017	0.3751		0.4259	0.3853		0.4483	0.3919
EB	0.3698	0.3703	FB	0.3941	0.3848	GB	0.4221	0.3985	HB	0.4467	0.4076
	0.3736	0.3874		0.3996	0.4015		0.4299	0.4165		0.4562	0.426
	0.3869	0.3958		0.4146	0.4089		0.443	0.4212		0.4687	0.4289
	0.3819	0.3777		0.4081	0.3918		0.4343	0.4030		0.4585	0.4102
EC	0.3819	0.3777	FC	0.4081	0.3918	GC	0.4343	0.4030	HC	0.4585	0.4102
	0.3869	0.3958		0.4146	0.4089		0.443	0.4212		0.4687	0.4289
	0.4006	0.4044		0.4299	0.4165		0.4562	0.426		0.4813	0.4319
	0.3943	0.3852		0.4223	0.3990		0.4467	0.4076		0.4701	0.4128
ED	0.3783	0.3646	FD	0.4017	0.3751	GD	0.4259	0.3853	HD	0.4483	0.3919
	0.3819	0.3777		0.4081	0.3918		0.4343	0.4030		0.4585	0.4102
	0.3943	0.3852		0.4223	0.3990		0.4467	0.4076		0.4701	0.4128
	0.3898	0.3716		0.4147	0.3814		0.4373	0.3893		0.4593	0.3944

6、光电特性图 The Photoelectric Characteristics Graph

a)、光谱图 Color Spectrum, $T_j = 85^\circ\text{C}$

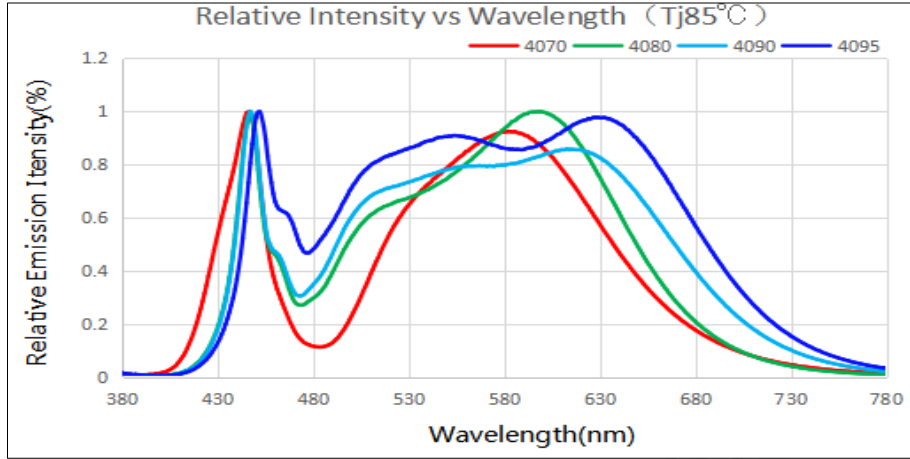

b)、Forward Voltage vs. Forward Current, $T_j = 85^\circ\text{C}$

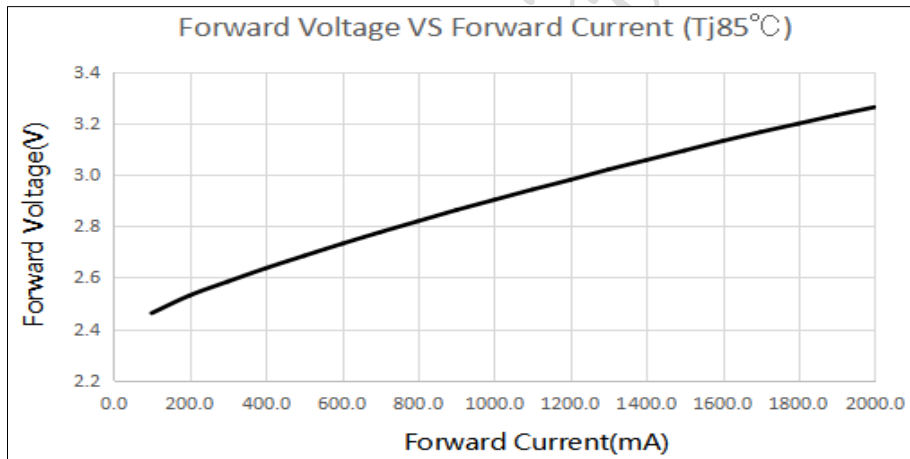

c)、Forward Current vs. Relative Luminous Flux, $T_j = 85^\circ\text{C}$

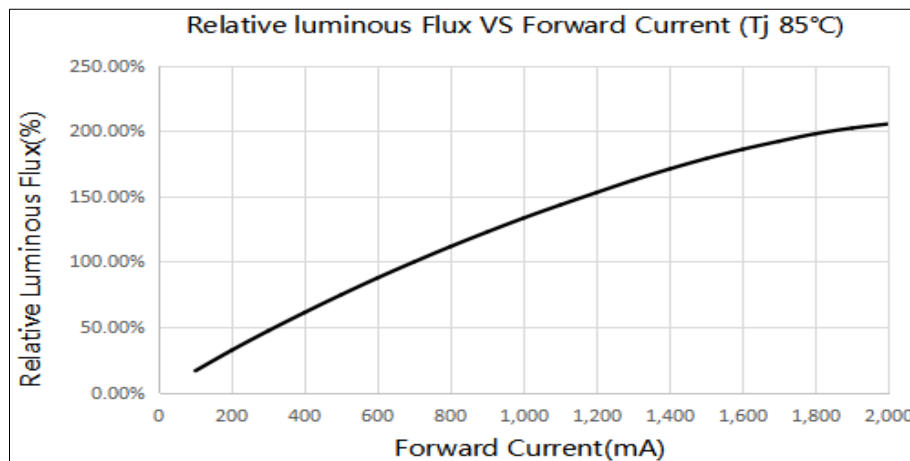

d) 、 Forward Current vs. ΔCCX ΔCCY , $T_j = 85^\circ C$

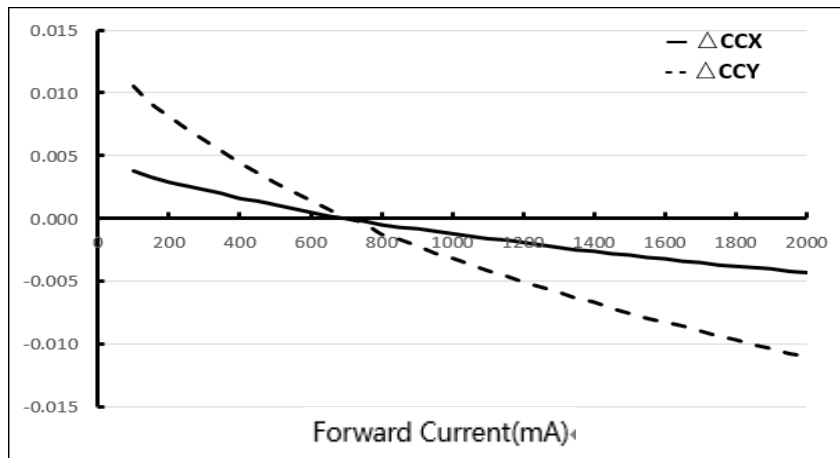

e) 、 Maximum Forward Current vs. Ambient Temperature, $T_j(\max.) = 150^\circ C$

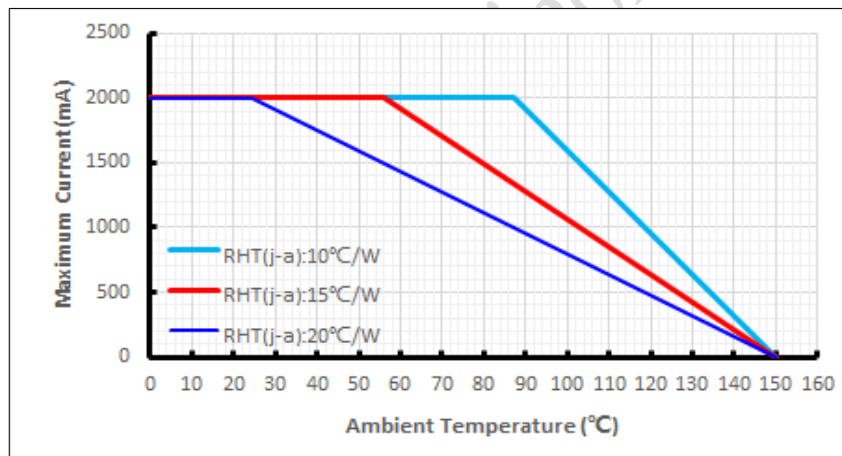

◇ 备注 Notes:

最大正向电流由 LED 结和环境之间的热阻决定。最终产品的设计方式应最大限度地减少从焊点到环境的热阻，以优化灯的寿命和光学特性。

The maximum forward current is determined by the thermal resistance between the LED junction and ambient. It is crucial for the end product to be designed in a manner that minimizes the thermal resistance from the solder point to ambient in order to optimize lamp life and optical characteristics

7、产品及钢网尺寸 Product and PCB Pad Dimensions

Product Dimensions:

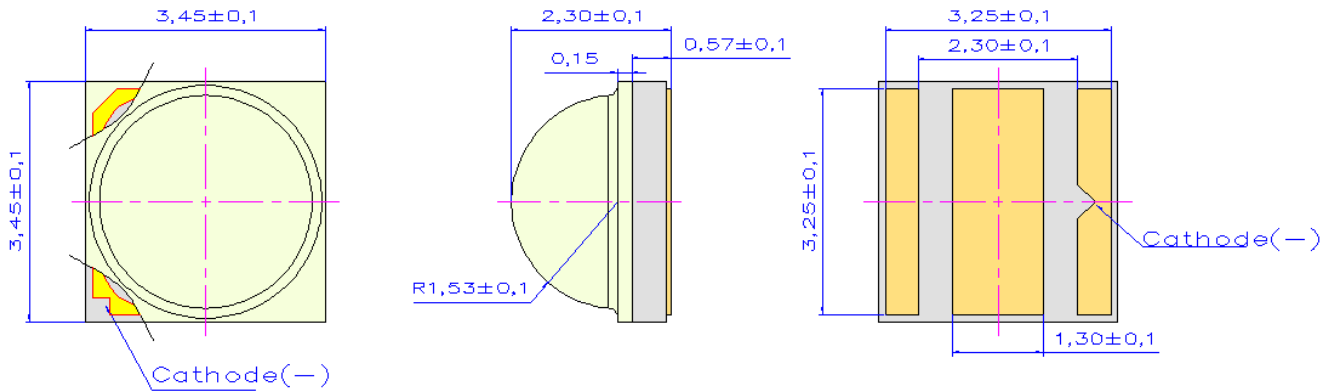

PCB Pad Dimensions:

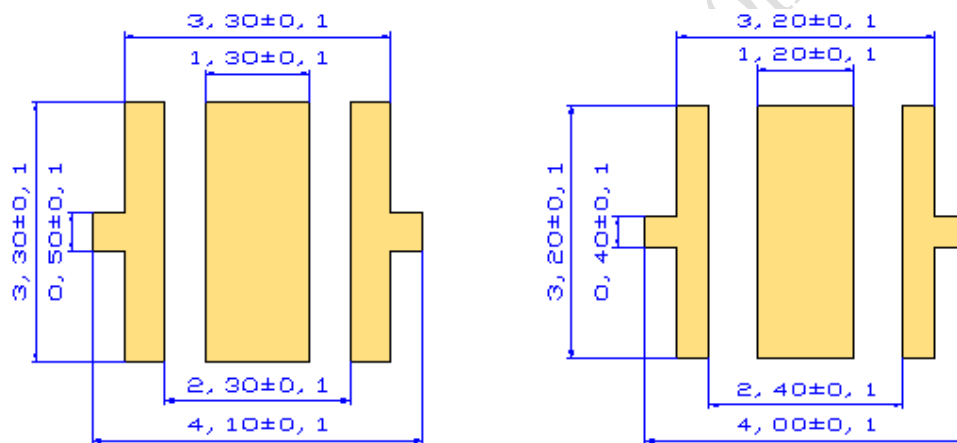

建议 PCB 焊盘

建议钢网

备注 Notes:

- ◇ 所有尺寸均以 mm 为单位
All dimensions are in millimeters
- ◇ 尺寸公差: $\pm 0,1$ mm
Dimension tolerance: $\pm 0,1$ mm

8、回流焊特性 Reflow Soldering Characteristics

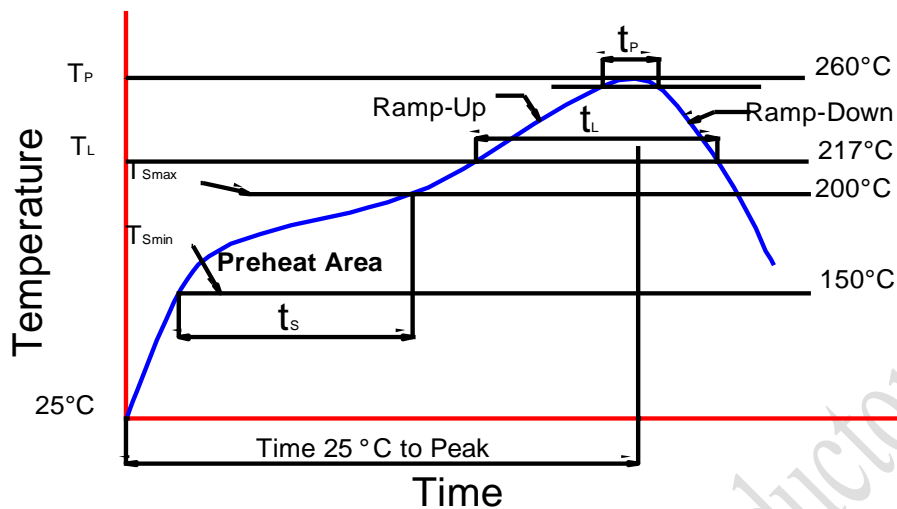

根据 EDEC-J-STD-020D 内容, 参考以下内容。

Compatible with the JEDEC-J-STD-020D, using the parameters listed below.

特制参数 Profile Feature	无铅焊料 Lead-Free Solder
平均上升速率 (T _{Smax} 至 T _P) Average Ramp-Up Rate (T _{Smax} to T _P)	3 °C/sec max.
预热: 温度最小值 (T _{Smin}) Preheat: Temperature Min (T _{Smin})	150
预热: 最高温度 (T _{Smax}) Preheat: Temperature Max (T _{Smax})	200
预热: 时间 (t _{Smin} 到 t _{Smax}) Preheat: Time (t _{Smin} to t _{Smax})	60-180 secs
回流温度 (T _L) Time Maintained Above: Temperature (T _L)	217°C
回流时间 (t _L) Time Maintained Above: Time (t _L)	60-150 secs
峰值/分类温度 (T _P) Peak/Classification Temperature (T _P)	255±5°C
实际峰值温度 (t _P) 在 5°C 以内的时间 Time Within 5°C of Actual Peak Temperature (t _P)	20~40 secs
降低速率 Ramp-Down Rate	5°C/sec max.

9、卷轴 Reel Dimensions

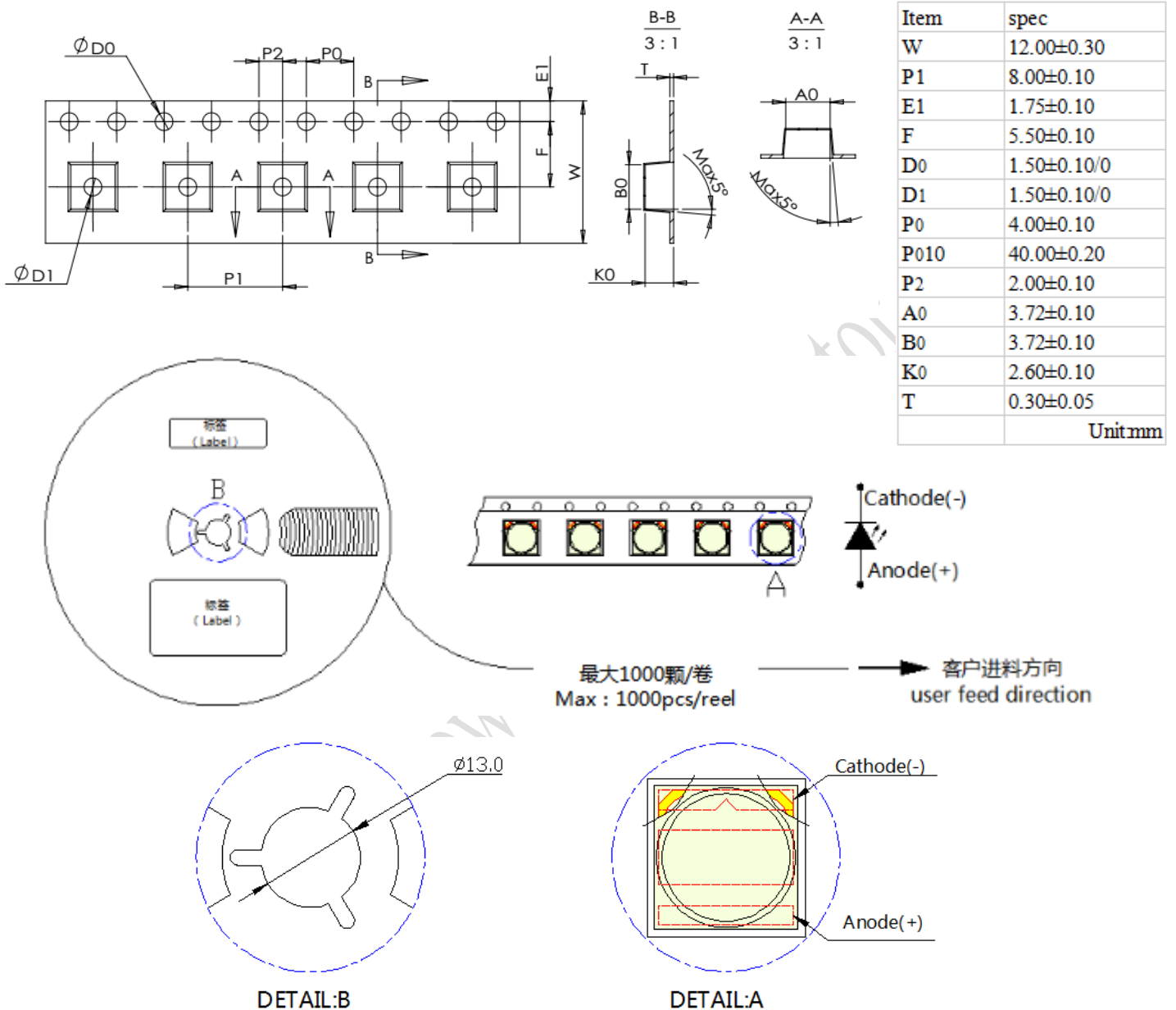

备注 Notes:

- ◇ 卷轴包装 1000pcs
Reel:1000pcs.
- ◇ 卷轴包装方法符合 IJSC0806 (连续胶带上的电子元件包装)
The tape packing method complies with IJSC0806(Packing of Electronic Components on Continuous Tapes).
- ◇ 当卷轴由于工作中断而重绕时, 载带上压力不应超过 10N, 否则 LED 可能会粘在盖带上
When the tape is rewound due to work interruptions, no more than 10N should be applied to the embossed carrier tape.
The LEDs may stick to the cover tape.

10、可靠性 Reliability

a) 测试和结果 Tests and Results

测试项目 Test Item	参考标准 Reference Standard	测试条件 Test Conditions	测试周期 Test Duration	失效标准 Failure Criteria#	失效数/测试数 Units Failed/Tested
可焊性 (回流焊) Solderability(Reflow Soldering)	JEITA ED=4701 303 303A	$T_{sld}=255\pm$ 5°C,5sec,Lead-free Solder(Sn-3.0Ag-0.5Cu)	3times	#2	0/10
高低温循环 Temperature Cycle	JEITA ED=4701 100 105	-40°C(30min)~25°C (5min)~ 85°C(30min)~25°C(5min)	100cycles	#1	0/10
高温/低温储存 High/Low Temperature Storage	JEITA ED=4701 200 201/ JEITA ED=4701 200 202	$T_A=125^\circ\text{C}/T_A=-40^\circ\text{C}$	1000h	#1	0/10
冷热冲击 Thermal_Shock	JESD22-A106	-40°C 15min fl < 3min 125°C 15min	1000Cycles	冷热冲击 Thermal_Shock	0/10
高温老化 High Temperature Operating		$T_A=85^\circ\text{C}, I_F=2000\text{mA}$	1000h	#1	0/10
高温高湿老化 Temperature Humidity Operating		85°C, RH=85%, $I_F=2000\text{mA}$	1000h	#1	0/10

b) 失效判定 Failure Criteria

判定 Criteria #	项目 Items	条件 Conditions	失效判定 Failure Criteria
#1	正向电压 Forward Voltage (VF)	I_F	> 初始值×1.1 倍 > Initial value×1.1
	光通量 Luminous Flux (Φ_v)	I_F	< 初始值×0.7 倍 < Initial value×0.7
	反向电流 Reverse Current (IR)	$V_R=5V$	> 1uA > 1uA
#2	回流焊 Solderability	-	焊接面积 < 80% Less than 80% solder coverage

11、注意事项 Cautions

a) 操作注意 Handling Precautions



1) LED 上的压力会影响 led 的可靠性。应采取预防措施，以避免对 led 的强压力。在加热过程中不要对 led 施加压力。

Pressure on the LEDs will influence to the reliability of the LEDs. Precautions should be taken to avoid strong pressure on the LEDs. Do not put stress on the LEDs during heating.

2) LED 焊接完毕后不应重新焊接。如果重新焊接不可避免，那么在修复之前和修复之后都要仔细检查 LED 的特性。

Re-soldering should not be done after the LEDs have been soldered. If re-soldering is unavoidable, LED's characteristics should be carefully checked before and after such repair.

3) 不要将组装好的 pcb 堆在一起。由于 LED 的材料是软的，与 LED 组装的两个 PCB 之间的磨损可能会导致 LED 破坏性的故障。

Do not stack assembled PCBs together. Since materials of LEDs is soft, abrasion between two PCB assembled with LED might cause catastrophic failure of the LEDs.

4) 与标准的封装材料相比，硅胶通常更柔软，表面更容易吸引灰尘，如果不能保证最低程度的灰尘和灰尘颗粒，在部件焊接后，必须在表面使用合适的清洗液。

Compared to standard encapsulants, silicone is generally softer, and the surface is more likely to attract dust, In cases where a minimal level of dirt and dust particles cannot be guaranteed, a suitable cleaning solution must be applied to the surface after the soldering of components.

5) 灯具材料中释放的挥发性有机化合物(VOCs)可以穿透 LED 的硅树脂封装，暴露在热量和光子能量下会变色。结果可能是灯具的光输出有重大损失。

VOCs (Volatile organic compounds) emitted from materials used in the construction of fixtures can penetrate silicone encapsulants of LED and discolor when exposed to heat and photonic energy. The result can be a significant loss of light output from the fixture.

6) 安装 led 时，不要使用释放有机蒸汽的粘合剂。

Attaching LEDs, do not use adhesives that outgas organic vapor..



7) LED 对 ESD (Electro-Static Discharge, ESD)敏感。以下是晶能半导体公司为减少这些影响而提出的一些建议。

LED is sensitive to Electro-Static Discharge (ESD). Below is a list of suggestions that LatticePower Semiconductor purposes to minimize these effects.

a. ESD(静电放电)

静电放电(ESD)定义为两个物体接触时释放出的静电。虽然大多数 ESD 事件被认为是无害的,但在许多工业环境中,在生产和存储期间,它可能是一个代价比较大的问题。ESD 对 LED 的损害可能导致产品显示出不同寻常的特性,例如:一反向泄漏电流的增加降低了开启电压

ESD (Electro Static Discharge)

Electrostatic discharge (ESD) is the defined as the release of static electricity when two objects come into contact. While most ESD events are considered harmless, it can be an expensive problem in many industrial environments during production and storage. The damage from ESD to an LED may cause the product to demonstrate unusual characteristics such as: - Increase in reverse leakage current lowered turn-on voltage.

-LED 在低电流时发射异常 Abnormal emissions from the LED at low current

以下建议可以帮助减少 ESD 发生的可能性。

The following recommendations are suggested to help minimize the potential for an ESD event.

一个或多个工作区域建议:

One or more work area suggestions:

-电离风扇设置 Ionizing fan setup

-导电材料制成的防静电台面/搁板垫 ESD table/shelf mat made of conductive materials

-防静电安全容器 ESD safe storage containers

一个或多个人员建议选择::

One or more personnel suggestion options:

-防静电腕带 Antistatic wrist-strap

-防静电材料鞋 Antistatic material shoes

-防静电衣服 Antistatic clothes

环境控制:

Environmental controls:

-湿度控制(干燥环境下防静电效果较差) Humidity control (ESD gets worse in a dry environment)

b) 清洗 Cleaning

1) 建议使用异丙醇进行清洗。如果使用其他溶剂, 必须保证这些溶剂不溶解包装或树脂。不建议使用超声波清洗。超声波清洗可能会对 LED 造成损坏。

We suggests using isopropyl alcohol for cleaning. In case other solvents are used, it must be assured that these solvents do not dissolve the package or resin. Ultrasonic cleaning is not recommended. Ultrasonic cleaning may cause damage to the LED.

c) 存储 Storage

➤ 不要将 LED 放在潮湿的地方, 存放温度在 5°C~30°C 之间, 相对湿度在 30% 以下。
Do not place the LED in damp places, Storage temperature between 5 °C and 30 °C, Relative humidity under 30%.

➤ 打开包装后使用注意事项 Use Precaution after Opening the Packaging

a) 开包后推荐条件 Recommend conditions after opening the package

- 密封/温度: 5~30°C 湿度: 小于 60%

- Sealing / Temperature : 5 ~ 30°C Humidity : less than RH60%

b) 如果包装已打开超过 168H(MSL 3) 或湿度指示卡颜色发生变化, 应在 65±5°C 条件下干燥 10-24H

If the package has been opened more than 168 hours (MSL 3) or the color of the Humidity indicator card changes, components should be dried for 10-24hr at 65±5°C