

江西省晶能半导体有限公司

JiangXi LatticePower Semiconductor Corporation

产 品 规 格 书 Specification

产品名称 Product Name: 3535-RGB

产品型号 Product P/N: M3

客 户 Client name: _____

客户料号 Client P/N: _____

版 本 号 Version No.: A00

日 期 Sending Date: 2020.7.13

客户承认栏 Client Approval	
核准 Approval	确认 Audit

制定 Confirmation: _____ 审核 Approval: _____

工厂地址:江西省南昌市高新区艾溪湖北路 699 号

Address: No.699 Aixihu North Road, Nanchang, Jiangxi Province, China

目录 Contents

1、特点 Features.....	1
2、应用 Applications.....	1
3、性能 Performance.....	2
4. 产品代码 Product Order Code.....	4
5、光电特性图 The Photoelectric Characteristics Graph.....	5
6. 产品及钢网尺寸 Product and PCB Pad Dimensions.....	6
7、回流焊特性 Reflow Soldering Characteristics.....	7
8、卷轴 Reel Dimensions.....	8
9、可靠性验证 Reliability.....	9
10、注意事项 Cautions.....	10

1、特点 Features

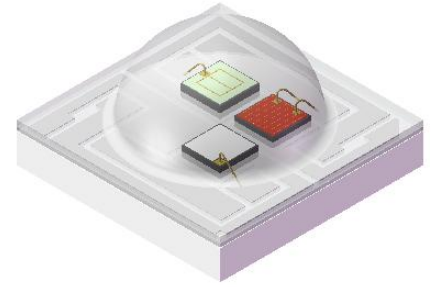

- ◆ 陶瓷封装，高亮度，高光效
Ceramic Substrate package , High brightness ,High efficiency
- ◆ 尺寸：3.5mm*3.5mm
Size: 3.5mm*3.5mm
- ◆ 适于 SMT 贴片
Compatible with SMT
- ◆ 发光角度：120°
Viewing Angle: 120°
- ◆ 包装：最大 1000 颗/卷
Package: Max: 1000pcs /reel

2、应用 Applications

景观照明	Landscape lighting
车用照明	Automobile lighting
舞台照明	Stage lighting



3、性能 Performance

a) 绝对最大额定值 Absolute Maximum Ratings

参数 Parameter		符号 Symbol	最大参数值 Maximum Rating	单位 Unit
电流 Forward Current	红 Red	I_F	500	mA
	绿 Green		500	
	蓝 Blue		500	
功率 Power Dissipation	红 Red	P	1.50	W
	绿 Green		1.50	
	蓝 Blue		1.50	
反向电压 Reverse Voltage		V_R	5	V
工作温度 Operating Temperature Range		T_{opr}	-40~105	°C
存储温度 Storage Temperature		T_{stg}	-40~120	°C
ESD (人体模式) ESD Human Body Mode		----	2000	V

**b) 光电参数 Electro-Optical Characteristics (T solder pad =25 °C, I_F =350mA)**

项目 Item	符号 Symbol	最小值 Min.	典型值 Typ.	最大值 Max.	单位 Unit
光通量 Luminous Flux	红 Red	40	60	----	Lm
	绿 Green	75	85	----	
	蓝 Blue	15	20	----	
正向电压 Forward Voltage	红 Red	2.0	2.4	3.0	V
	绿 Green	2.5	3.0	3.5	
	蓝 Blue	2.5	3.0	3.5	
波长 Wavelength	红 Red	620	625	630	nm
	绿 Green	520	522	525	
	蓝 Blue	450	452	455	
热阻 Thermal Resistance	----	----	7.5	----	°C/W
发光角度 Viewing Angle	201/2	----	120	----	°
结温 LED Junction Temperature	T _j	----	125	----	°C

备注 Notes :

◇ 光通量测量误差范围±7%

Luminous flux measurement tolerance: ±7

4. 产品代码 Product Order Code

M3 - RW - DL - D3
 ① ② ③ ④

- ① 产品型号 Product Type
- ② 红光参数(亮度, 电压, 波长范围) Red parameter(Luminous Flux、Voltage、Wavelength)
- ③ 绿光参数(亮度, 电压, 波长范围) Green parameter(Luminous Flux、Voltage、Wavelength)
- ④ 蓝光参数(亮度, 电压, 波长范围) Blue parameter(Luminous Flux、Voltage、Wavelength)

T solder pad =25 °C, I_F =350mA

产品名称	测试项目	代码	红光		代码	绿光		代码	蓝光	
			MIN	MAX		MIN	MAX		MIN	MAX
M3	WLD	RW	615	630	DL	515	530	D3	430	470
	φ (1m)	BR	35	95	BG	70	120	BB	10	40
	VF2	R1	2	3	G1	2.5	3.5	G1	2.5	3.5

出货标签(例) Shipping label (e.g.)

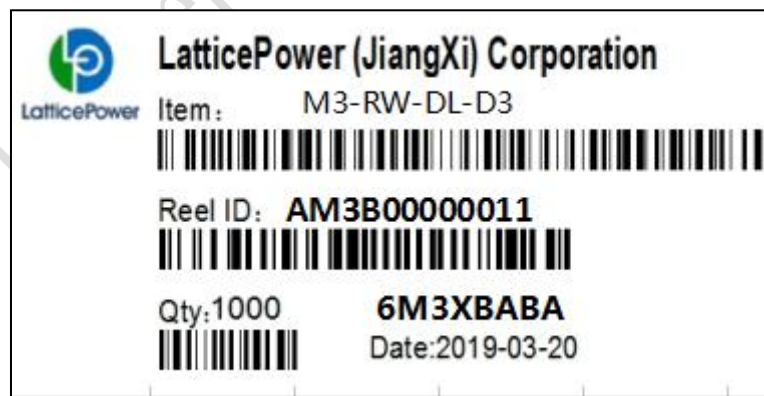

5、光电特性图

The Photoelectric Characteristics Graph (Ta= 25 °C)

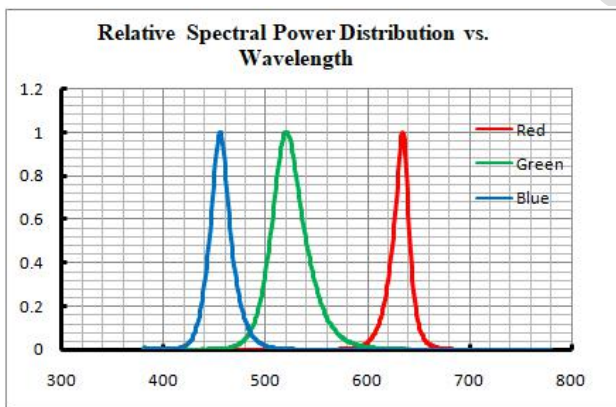
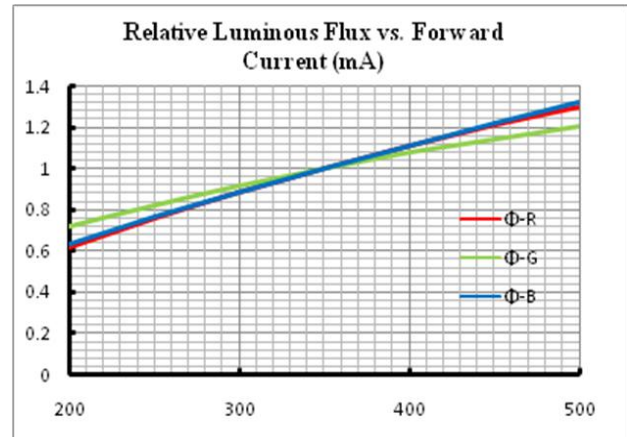
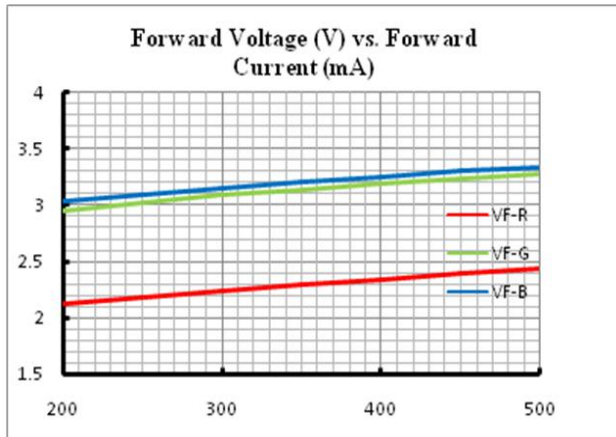

6. 产品及钢网尺寸 Product and PCB Pad Dimensions

Product Dimensions:

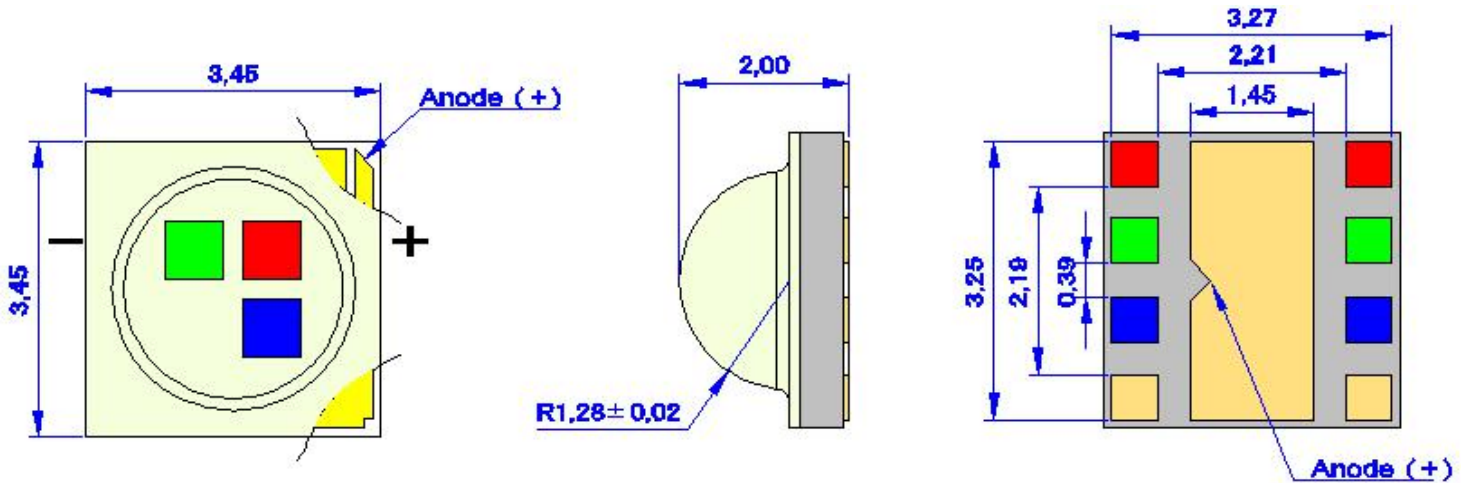

PCB Pad Dimensions:

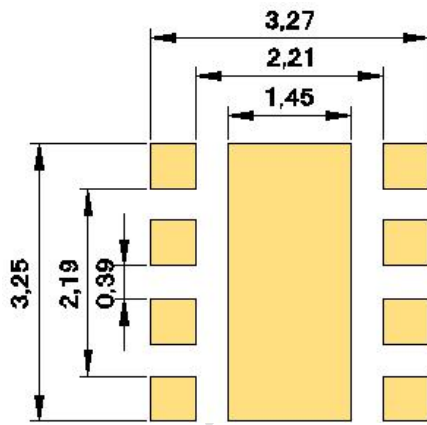

建议焊盘图

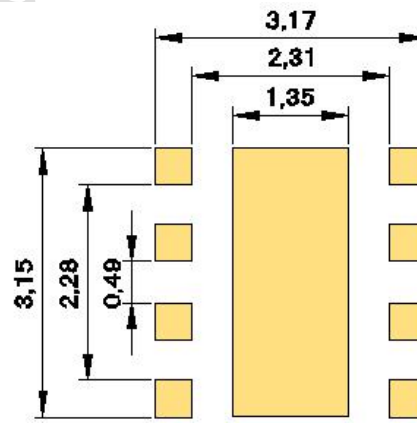

建议钢网图

备注 Notes:

- ◇ 所有尺寸均以 mm 为单位
All dimensions are in millimeters
- ◇ 尺寸未按照公差±0.1mm 标记的，按照图纸标记
Size is not marked in accordance with tolerance $\pm 0.1\text{mm}$ and dimension tolerances in accordance with drawings

7、回流焊特性 Reflow Soldering Characteristics

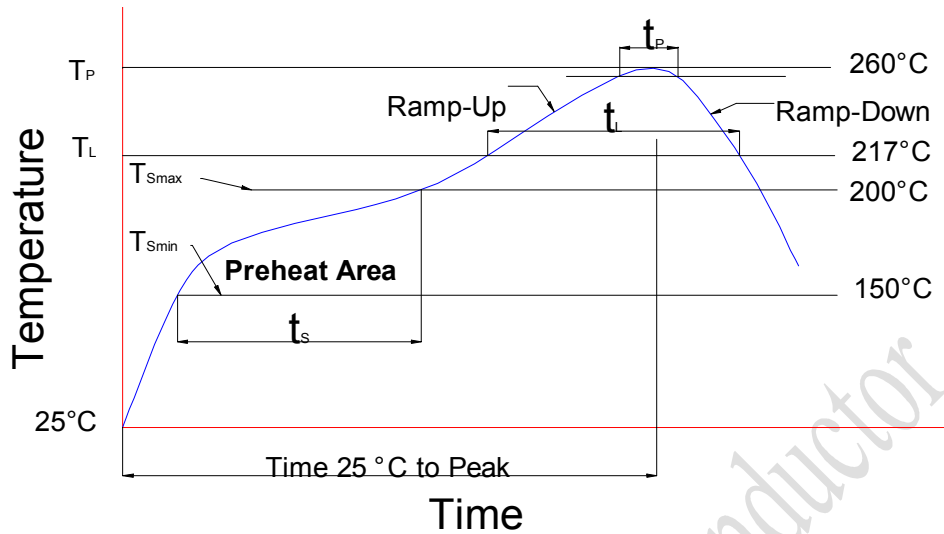

根据 EDEC-J-STD-020D 内容，参考以下内容。

Compatible with the JEDEC-J-STD-020D, using the parameters listed below.

特制参数 Profile Feature	无铅焊料 Lead-Free Solder
平均上升速率 (T _{Smax} 至 T _p) Average Ramp-Up Rate (T _{Smax} to T _p)	3 °C/sec max.
预热: 温度最小值 (T _{Smin}) Preheat: Temperature Min (T _{Smin})	150
预热: 最高温度 (T _{Smax}) Preheat: Temperature Max (T _{Smax})	200
预热: 时间 (t _{Smin} 到 t _{Smax}) Preheat: Time (t _{Smin} to t _{Smax})	60-180 secs
回流温度 (T _L) Time Maintained Above: Temperature (T _L)	217°C
回流时间 (t _L) Time Maintained Above: Time (t _L)	60-150 secs
峰值/分类温度 (T _p) Peak/Classification Temperature(T _p)	255 ± 5°C
实际峰值温度 (t _p) 在 5°C 以内的时间 Time Within 5°C of Actual Peak Temperature (t _p)	20~40 secs
降低速率 Ramp-Down Rate	5°C/sec max.

8、 卷轴 Reel Dimensions

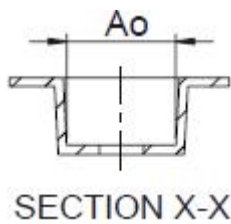
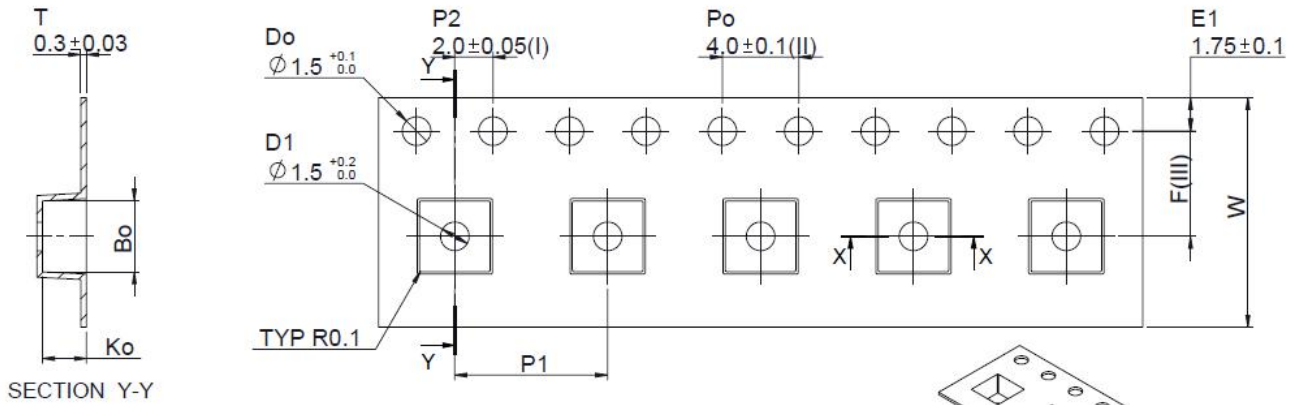

Ao	3.70 +/- 0.1
Bo	3.70 +/- 0.1
Ko	2.30 +/- 0.1
F	5.50 +/- 0.05
P1	8.00 +/- 0.1
W	12.00 +0.3/-0.1

备注 Notes:

- ◇ 卷轴包装 1000pcs
Reel:1000pcs.
- ◇ 卷轴包装方法符合 IJSC0806 (连续胶带上的电子元件包装)
The tape packing method complies with IJSC0806(Packing of Electronic Components on Continuous Tapes).
- ◇ 当卷轴由于工作中断而重绕时, 载带上压力不应超过 10N, 否则 LED 可能会粘在盖带上
When the tape is rewound due to work interruptions, no more than 10N should be applied to the embossed carrier tape.
The LEDs may stick to the cover tape.



9、可靠性 Reliability

a) 测试和结果 Tests and Results

测试项目 Test Item	参考标准 Reference Standard	测试条件 Test Conditions	测试周期 Test Duration	失效标准 Failure Criteria#	失效数/测试数 Units Failed/Tested
可焊性(回流焊) Solderability(Reflow Soldering)	JEITA ED=4701 303 303A	$T_{sld}=255\pm 5^{\circ}\text{C}$,5sec,Lead-free Solder(Sn-3.0Ag-0.5Cu)	3times	#2	0/12
高低温循环 Temperature Cycle	JEITA ED=4701 100 105	-40°C (30min) \sim 25°C (5min) \sim 85°C (30min) \sim 25°C (5min)	100cycles	#1	0/12
高温/低温储存 High/Low Temperature Storage	JEITA ED=4701 200 201/ JEITA ED=4701 200 202	$T_A=120^{\circ}\text{C}/T_A=-40^{\circ}\text{C}$	1000h	#1	0/12
高温老化 High Temperature Operating		$T_A=85^{\circ}\text{C}$, $I_F=500\text{mA}$ Test board: See NOTES below	1000h	#1	0/12
高温高湿老化 Temperature Humidity Operating		85°C , $\text{RH}=85\%$, $I_F=500\text{mA}$ Test board: See NOTES below	1000h	#1	0/12
震动 Vibration	JESD22-B103	10m/s^2 ,100~20000~100Hz,4cycles,4min, each X,Y,Z	5times	#1	0/6

b) 失效判定 Failure Criteria

判定 Criteria #	项目 Items	条件 Conditions	失效判定 Failure Criteria
#1	正向电压 Forward Voltage (V_F)	I_F	$>$ 初始值 $\times 1.1$ 倍 $>$ Initial value $\times 1.1$
	光通量 Luminous Flux (Φ_V)	I_F	$<$ 初始值 $\times 0.9$ 倍 $<$ Initial value $\times 0.9$
	反向电流 Reverse Current (I_R)	$V_R=5\text{V}$	$> 1\mu\text{A}$ $> 1\mu\text{A}$
#2	回流焊 Solderability	-	焊接面积 $< 80\%$ Less than 80% solder coverage

10、注意事项 Cautions

a) 存储 Storage

- 不要将芯片放在潮湿的地方，存放温度在 5℃~30℃之间，相对湿度在 30% 以下。
Do not place the chips in damp places, Storage temperature between 5 °C and 30 °C, Relative humidity under 30%.
- 开包后建议在 24 小时内过完回流焊，车间条件 ≤30℃/60%RH。
After opening the package, it is recommended to finish the reflow within 24 hours. The workshop conditions are ≤30°C/60%RH
- 如果受潮，需将贴片卷盘放入 60℃烤箱烘烤 24 小时；打开后，LED 灯可重新密封在原始真空袋中。
If it is wet, the patch reel should be baked in a 60 ° C oven for 24 hours; after opening, the LED light can be resealed in the original vacuum bag.
- 不要接触任何未知的液体，特别是丙酮。
Don't touch any unknown liquid, In particular, acetone.
- 防止静电死亡，手动操作需要戴橡胶手套并佩戴静电环。
Prevent electrostatic killed, Manual operation is required to wear rubber gloves and wear electrostatic ring.

b) 清洗 Cleaning

- 通常，LED 不建议对部件进行湿式清洁处理，因为封装不是密封的。
In general, LED does not recommend a wet cleaning process for component as the package is not hermetically sealed.
- 由于采用开放式设计，所有类型的清洁液都可能渗透到封装中，导致 LED 退化或完全失效。
Due to the open design, all kind of cleaning liquids can infiltrate the package and cause a degradation or a complete failure of the LED.

c) 操作注意 Handling Precautions



- 在处理过程中，还应注意确保组件顶面没有压力
During the handling, care should be taken as well to ensure no pressure on the top surface of component.
- 应避免使用所有类型的尖锐物体（例如镊子，指甲等），以防止对硅树脂造成压力，因为这会导致部件损坏。
All types of sharp objects(e.g. forceps, fingernail, etc) should be avoided in order to prevent stress to the silicone, since this can lead to damage of the component.



11、 文件履历表 Document Resume

序号	变更日期	变更人	版本	变更内容
1	2020.7.13	王宝	A00	新版发行

LatticePower Semiconductor