

江西省晶能半导体有限公司  
JiangXi LatticePower Semiconductor Corporation

产 品 规 格 书  
Specification

产品名称 Product Name: HF

产品型号 Product P/N: \_\_\_\_\_

客 户 Client name: \_\_\_\_\_

客户料号 Client P/N: \_\_\_\_\_

版 本 号 Version No.: A00

日 期 Sending Date: 2020.7.9

客户承认栏 Client Approval	
核准 Approval	确认 Audit

制定 Confirmation: \_\_\_\_\_ 审核 Approval: \_\_\_\_\_

工厂地址:江西省南昌市高新区艾溪湖北路 699 号

Address: No.699 Aixihu North Road, Nanchang, Jiangxi Province, China

# 目录

## Contents

1、特点 Features.....	1
2、应用 Applications.....	1
3、性能 Performance.....	2
4. 产品代码 Product Order Code.....	4
5. 分档规则 Bin Regulations.....	5
6、光电特性图 The Photoelectric Characteristics Graph.....	9
7. 产品及钢网尺寸 Product and PCB Pad Dimensions.....	10
8、回流焊特性 Reflow Soldering Characteristics.....	11
9、卷轴 Reel Dimensions.....	12
10、可靠性验证 Reliability.....	13
11、注意事项 Cautions.....	14

## 1、特点 Features

- ◆ 陶瓷封装，高亮度，高光效  
Ceramic Substrate package , High brightness ,High efficiency
- ◆ 尺寸：2.5mm\*2.5mm  
Size: 2.5mm\*2.5mm
- ◆ 根据 ANSI 标准分档  
According to the ANSI standard colour gamut
- ◆ 适于 SMT 贴片  
Compatible with SMT
- ◆ 发光角度：120°  
Viewing Angle: 120°
- ◆ 包装：最大 2000 颗/卷  
Package: Max: 2000pcs /reel

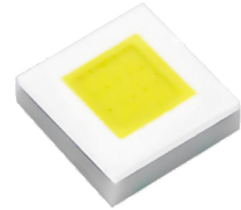

## 2、应用 Applications

汽车照明	Automobile
路灯照明	Street lighting
隧道照明	Tunnel lighting
工业照明	High-bay





### 3、性能 Performance

#### a) 绝对最大额定值 Absolute Maximum Ratings

参数 Parameter	符号 Symbol	最大参数值 Maximum Rating	单位 Unit
电流 DC ( Video Mode ) Forward Current	$I_F$	1200	mA
功率 Power Dissipation	P	3.90	W
脉冲电流 Pulsed(Flash Mode) Forward Current	$I_{FP}$	1500	mA
反向电压 Reverse Voltage	$V_R$	5	V
工作温度 Operating Temperature Range	$T_{opr}$	-40~105	°C
存储温度 Storage Temperature	$T_{stg}$	-40~120	°C
ESD (人体模式) ESD Human Body Mode	----	2000	V

#### b) 光电参数 Electro-Optical Characteristics (T solder pad =25 °C, $I_F$ =350mA)

项目 Item	符号 Symbol	最小值 Min.	典型值 Typ.	最大值 Max.	单位 Unit
光通量 Luminous Flux	$\Phi$	150	170	180	Lm
正向电压 Forward Voltage	VF	2.5	2.9	3.25	V
显指 Ra	----	----	70	----	----
热阻 Thermal Resistance	----	----	6.5	----	°C/W
发光角度 Viewing Angle	201/2	----	120	----	°
结温 LED Junction Temperature	$T_j$	----	150	----	°C

### c) 亮度分布特性

#### Luminous Flux Characteristics (T solder pad = 25 °C, I<sub>F</sub> = 350mA)

常规色温 Normal CCT	典型显指 Typ. Ra	色区块 Chromaticity	亮度等级 Flux Rank / 最小光通量 min Flux				
			S2A 140	S3A 150	S4A 160	S5A 170	S6A 180
6000K	70	1C、1D、2A、2B		•	•	•	

#### 金黄光 AMBER

常规色温 Normal CCT	波长 Wavelength	色区块 Chromaticity	亮度等级 Flux Rank / 最小光通量 min Flux		
			L1 100	L2 110	L3 120
			PC AMBER	587.5-595	PA1、PA2

备注 Notes :

◇ 光通量测量误差范围±7%

Luminous flux measurement tolerance: ±7%

#### 4. 产品代码 Product Order Code

HF   -   B   -   1A   -   S4A   -   DD5  
 ①            ②            ③            ④            ⑤

- ① 产品型号      Product Type
- ② 显色指数      Ra level
- ③ 色温区块      Colour Area
- ④ 亮度等级      Brightness Level
- ⑤ 电压等级      VF Level

#### 出货标签(例) Shipping label (e.g.)

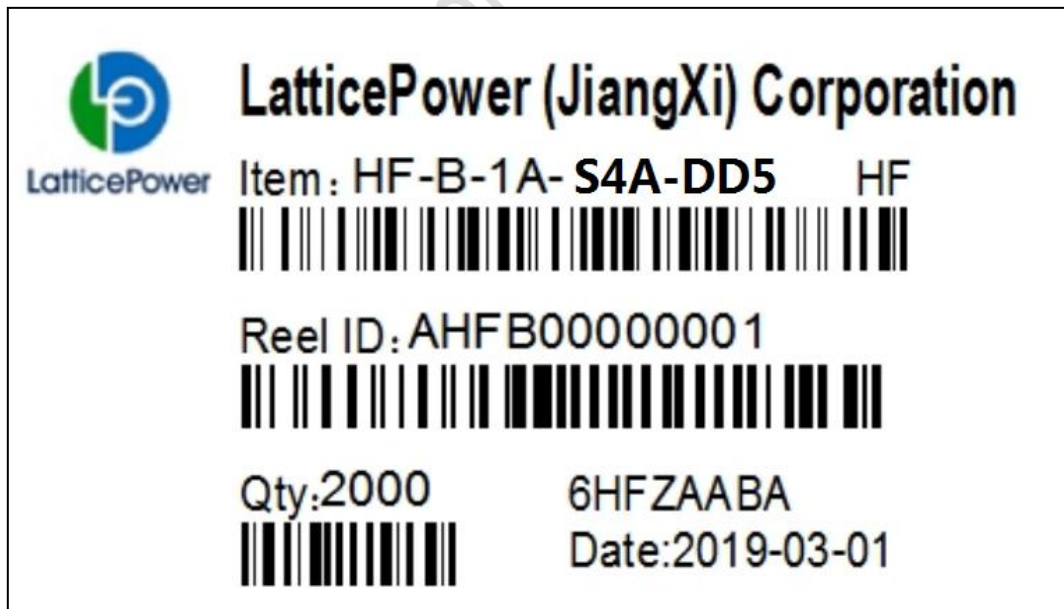

## 5. 分档规则 Bin Regulations

### a) 色度区域 Chromaticity Regions

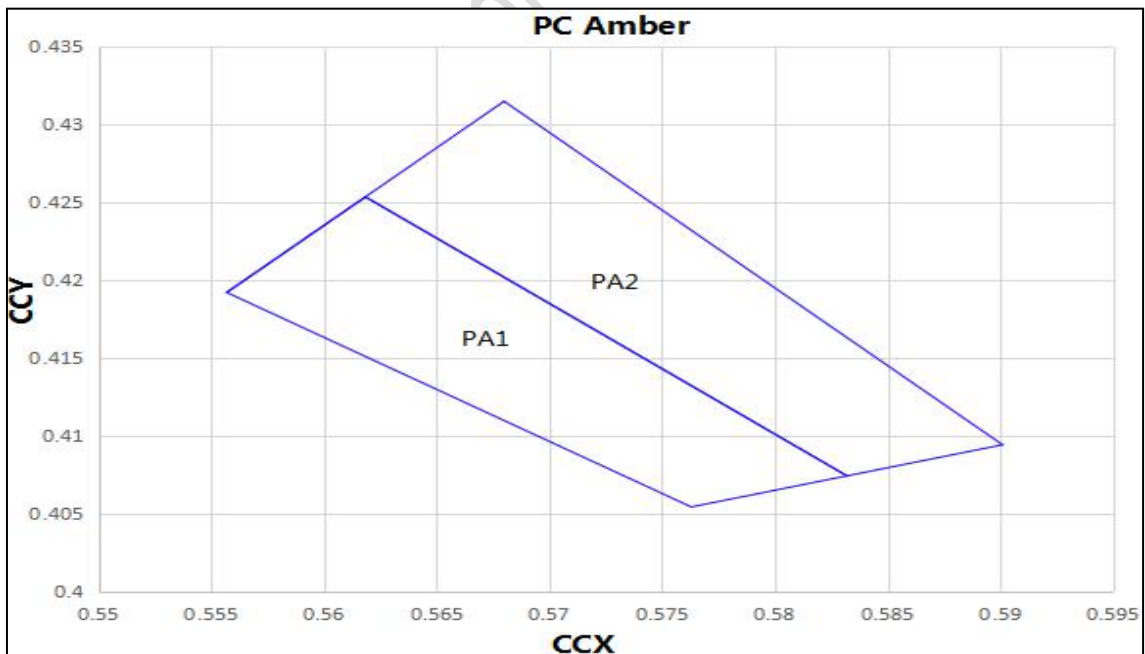
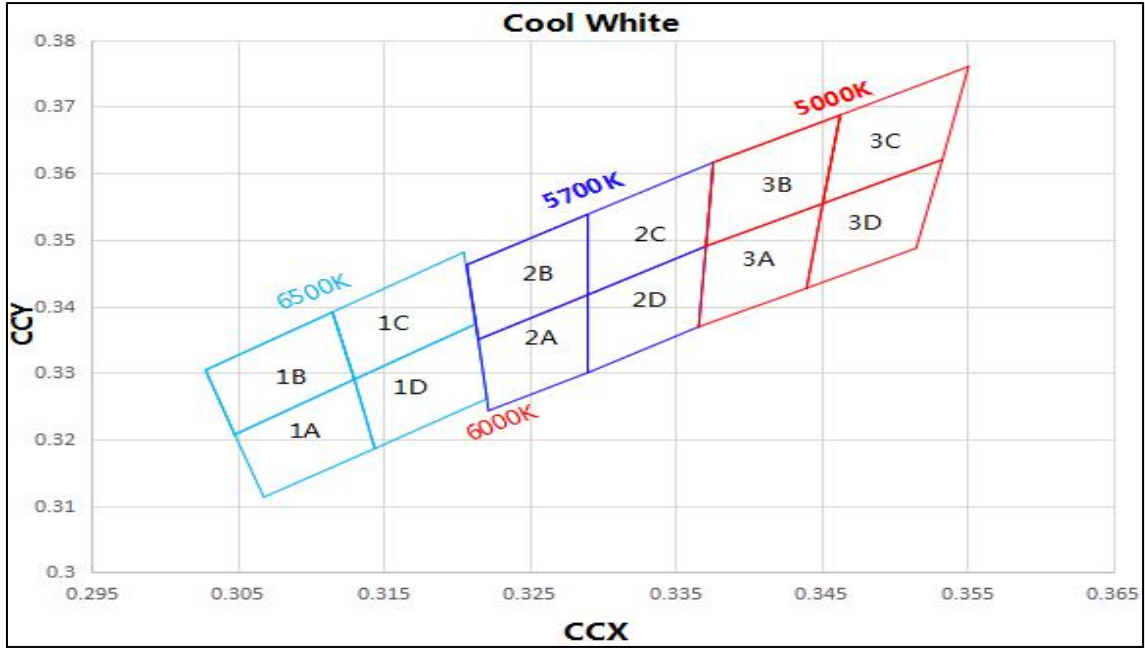

色区	X	Y	色区	X	Y	色区	X	Y	色区	X	Y		
1A	0.3048	0.3207	1B	0.3028	0.3304	1C	0.3115	0.3391	1D	0.3130	0.3290		
	0.3130	0.3290		0.3115	0.3391		0.3205	0.3481		0.3213	0.3373	0.3213	0.3373
	0.3144	0.3186		0.3130	0.3290		0.3213	0.3373		0.3130	0.3290	0.3144	0.3186
	0.3068	0.3113		0.3048	0.3207		0.3130	0.3290		0.3130	0.3290	0.3144	0.3186
2A	0.3215	0.3350	2B	0.3207	0.3462	2C	0.3290	0.3538	2D	0.3290	0.3417		
	0.3290	0.3417		0.3290	0.3538		0.3376	0.3616		0.3371	0.3490	0.3371	0.3490
	0.3290	0.3300		0.3290	0.3417		0.3371	0.3490		0.3290	0.3417	0.3366	0.3369
	0.3222	0.3243		0.3215	0.3350		0.3290	0.3417		0.3290	0.3417	0.3290	0.3300
3A	0.3371	0.3490	3B	0.3376	0.3616	3C	0.3463	0.3687	3D	0.3451	0.3554		
	0.3451	0.3554		0.3463	0.3687		0.3551	0.3760		0.3533	0.3620	0.3533	0.3620
	0.3440	0.3427		0.3451	0.3554		0.3533	0.3620		0.3515	0.3487	0.3515	0.3487
	0.3366	0.3369		0.3371	0.3490		0.3451	0.3554		0.3440	0.3427	0.3440	0.3427

色区	X	Y	色区	X	Y	色区	X	Y	色区	X	Y
PA1	0.5557	0.4192	PA2	0.5619	0.4254						
	0.5619	0.4254		0.5680	0.4315						
	0.5832	0.4074		0.5901	0.4094						
	0.5763	0.4054		0.5832	0.4074						

备注 Notes :

- ◇ 色度坐标 (x, y) 来自 CIE1931 色度图  
The chromaticity coordinates(x,y)is derived from the CIE 1931 chromaticity diagram
- ◇ PT86 测试设备用于光通量 (lm) 和 CIE1931 色度坐标 (x, y) 测试。  
PT86 is for the luminous flux(lm) and the CIE1931 chromaticity coordinates(x,y) testing.
- ◇ 色度坐标 (x, y) 存在±0.006 公差。  
The chromaticity coordinates(x,y) guarantee should be added ±0.006 tolerance.



**b) 亮度分档 Luminous Flux Groups (T solder pad = 25°C, I<sub>F</sub> = 350 mA)**

代码 Group Code	最小值 Min.	最大值 Max.
L1	100	110
L2	110	120
L3	120	130
L4	130	140
S2A	140	150
S3A	150	160
S4A	160	170
S5A	170	180
S6A	180	200

**c) 电压分档 Voltage Groups**

代码 Group Code	范围 Range
DD5	2.5-2.75
DD6	2.75-3.0
DD7	3.0-3.25

备注 Notes :

◇ 亮度测试存在±7%的公差

It maintains a tolerance of ±7% on luminous flux measurements.

#### d) 显指分档 Ra Groups

代码 Group Code	范围 Range
B	60~100
B1	70~100
H1	80~100

备注 Notes :

◇ 显指测试存在 $\pm 2$ 的公差

It maintains a tolerance of  $\pm 2$  on CRI measurements

## 6、光电特性图

### The Photoelectric Characteristics Graph (Ta= 25 °C,6000K)

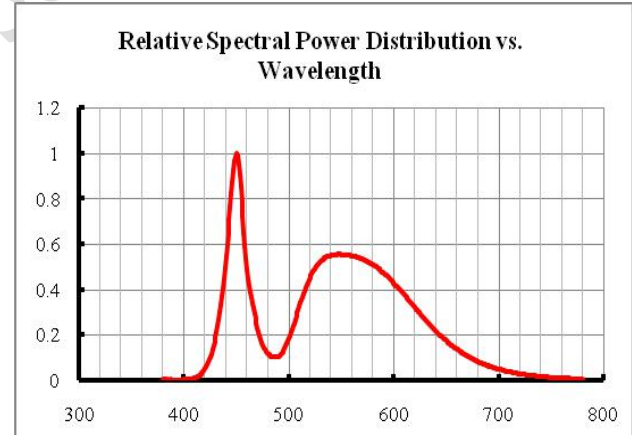
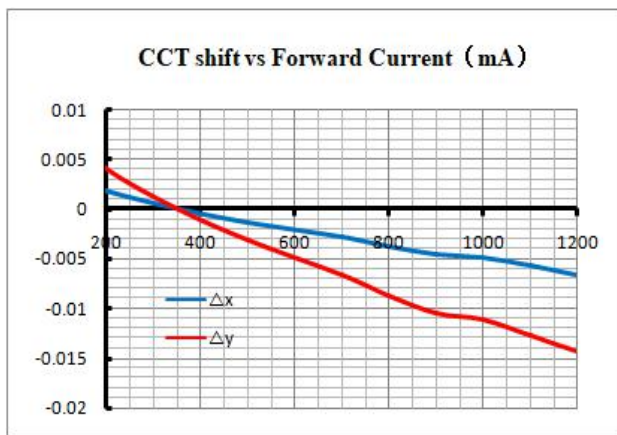
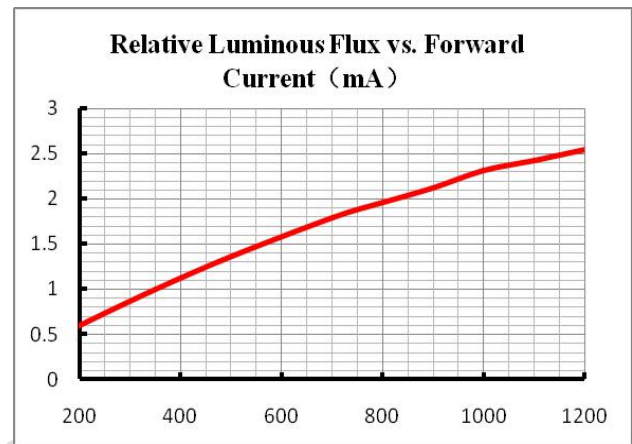
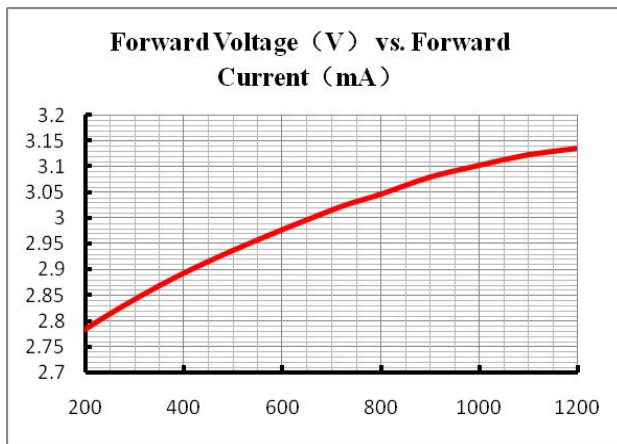

## 7. 产品及钢网尺寸 Product and PCB Pad Dimensions

### Product Dimensions:

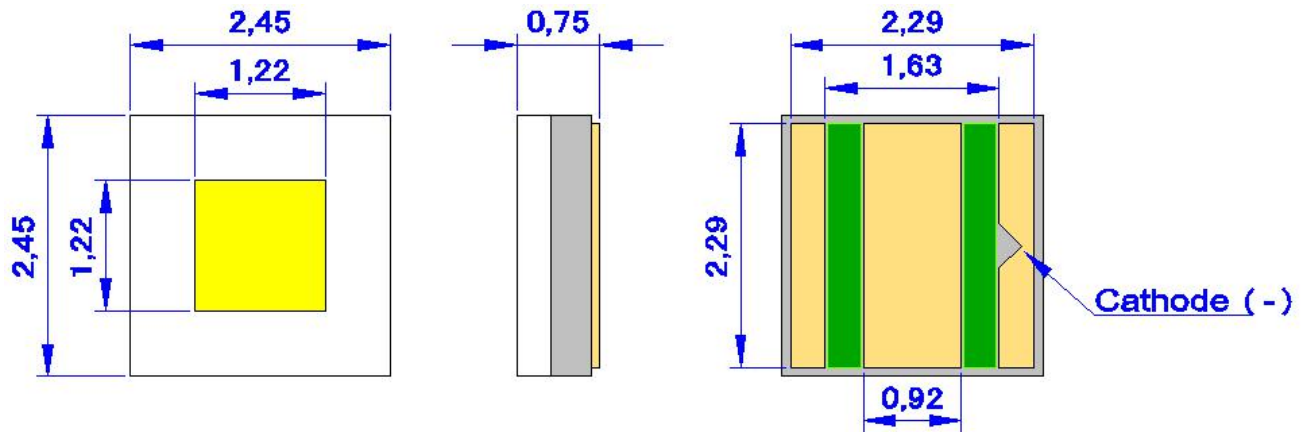

### PCB Pad Dimensions:

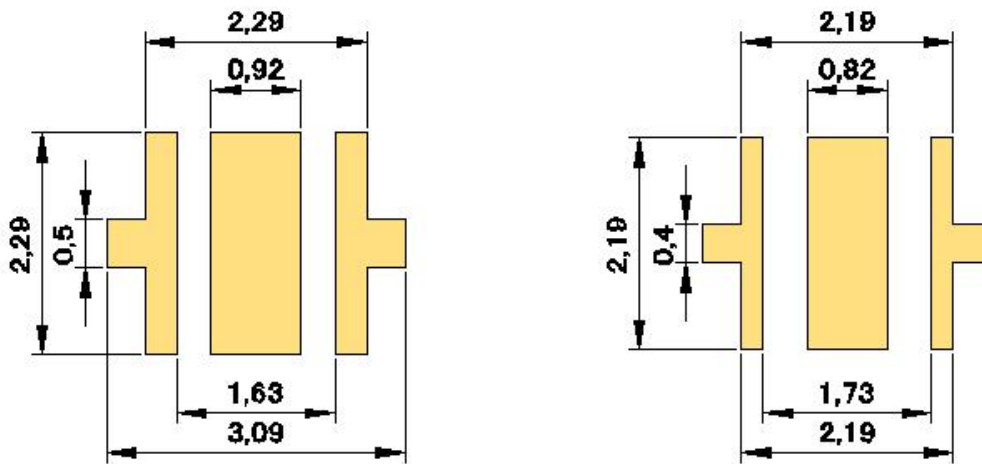

建议焊盘图

建议钢网图

备注 Notes:

◇ 所有尺寸均以 mm 为单位

All dimensions are in millimeters

◇ 尺寸未按照公差 $\pm 0.1\text{mm}$ 标记的, 按照图纸标记

Size is not marked in accordance with tolerance  $\pm 0.1\text{mm}$  and dimension tolerances in accordance with drawings

## 8、回流焊特性 Reflow Soldering Characteristics

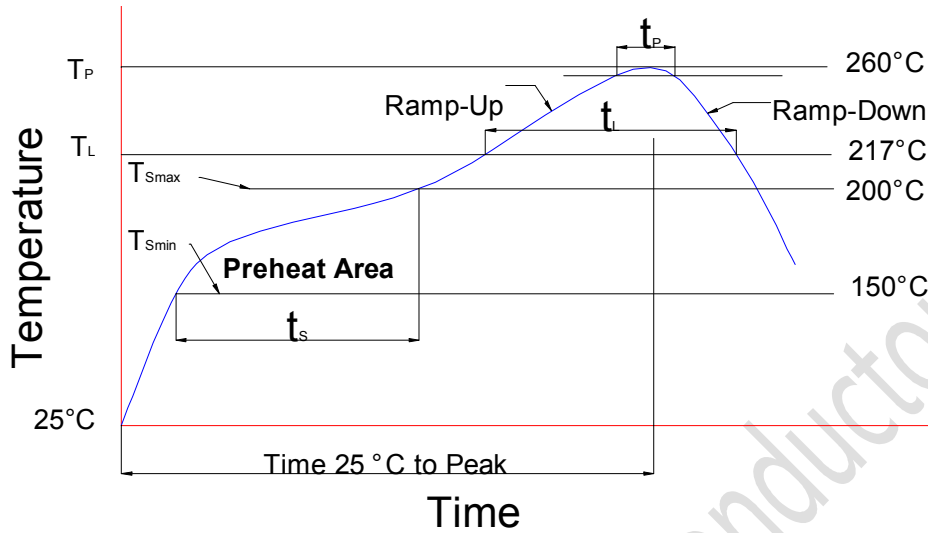

根据 EDEC-J-STD-020D 内容，参考以下内容。

Compatible with the JEDEC-J-STD-020D, using the parameters listed below.

特制参数 Profile Feature	无铅焊料 Lead-Free Solder
平均上升速率 (T <sub>Smax</sub> 至 T <sub>P</sub> ) Average Ramp-Up Rate (T <sub>Smax</sub> to T <sub>P</sub> )	3 °C/sec max.
预热: 温度最小值 (T <sub>Smin</sub> ) Preheat: Temperature Min (T <sub>Smin</sub> )	150
预热: 最高温度 (T <sub>Smax</sub> ) Preheat: Temperature Max (T <sub>Smax</sub> )	200
预热: 时间 (t <sub>Smin</sub> 到 t <sub>Smax</sub> ) Preheat: Time (t <sub>Smin</sub> to t <sub>Smax</sub> )	60-180 secs
回流温度 (T <sub>L</sub> ) Time Maintained Above: Temperature (T <sub>L</sub> )	217°C
回流时间 (t <sub>L</sub> ) Time Maintained Above: Time (t <sub>L</sub> )	60-150 secs
峰值/分类温度 (T <sub>P</sub> ) Peak/Classification Temperature(T <sub>P</sub> )	255 ± 5°C
实际峰值温度 (t <sub>p</sub> ) 在 5°C 以内的时间 Time Within 5°C of Actual Peak Temperature (t <sub>p</sub> )	20~40 secs
降低速率 Ramp-Down Rate	5°C/sec max.

## 9、卷轴 Reel Dimensions

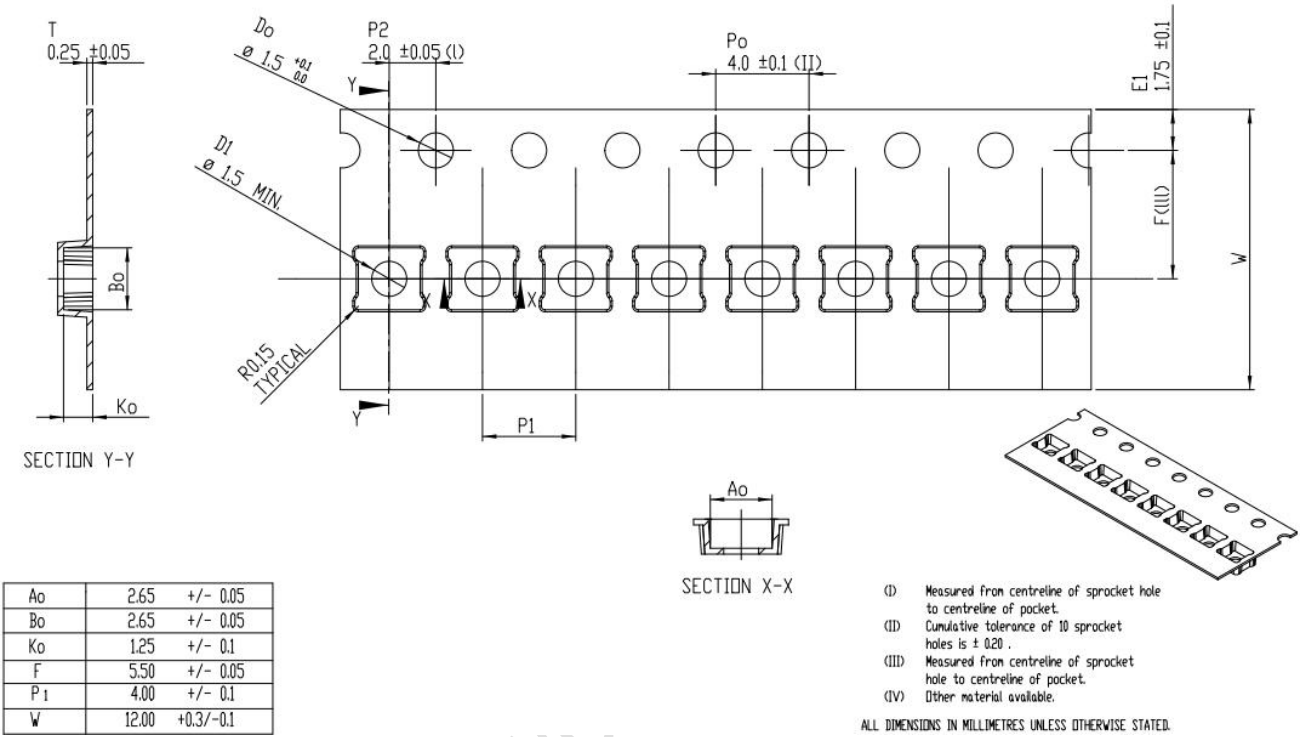

### 备注 Notes:

- ◇ 卷轴包装 2000pcs  
Reel:2000pcs.
- ◇ 卷轴包装方法符合 IJSC0806 (连续胶带上的电子元件包装)  
The tape packing method complies with IJSC0806(Packing of Electronic Components on Continuous Tapes).
- ◇ 当卷轴由于工作中断而重绕时, 载带上压力不应超过 10N, 否则 LED 可能会粘在盖带上  
When the tape is rewound due to work interruptions, no more than 10N should be applied to the embossed carrier tape.  
The LEDs may stick to the cover tape.



## 10、可靠性 Reliability

### a) 测试和结果 Tests and Results

测试项目 Test Item	参考标准 Reference Standard	测试条件 Test Conditions	测试周期 Test Duration	失效标准 Failure Criteria#	失效数/测试数 Units Failed/Tested
可焊性(回流焊) Solderability(Reflow Soldering)	JEITA ED=4701 303 303A	$T_{\text{std}}=255\pm 5^{\circ}\text{C}$ , 5sec, Lead-free Solder(Sn-3.0Ag-0.5Cu)	3times	#2	0/22
高低温循环 Temperature Cycle	JEITA ED=4701 100 105	$-40^{\circ}\text{C}$ (30min)~ $25^{\circ}\text{C}$ (5min)~ $85^{\circ}\text{C}$ (30min)~ $25^{\circ}\text{C}$ (5min)	100cycles	#1	0/22
高温/低温储存 High/Low Temperature Storage	JEITA ED=4701 200 201/ JEITA ED=4701 200 202	$T_{\text{A}}=120^{\circ}\text{C}/T_{\text{A}}=-40^{\circ}\text{C}$	1000h	#1	0/22
常温老化 Room Temperature Operating		$T_{\text{A}}=25^{\circ}\text{C}$ , $I_{\text{F}}=1200\text{mA}$ Test board: See NOTES below	1000h	#1	0/22
高温老化 High Temperature Operating		$T_{\text{A}}=70^{\circ}\text{C}$ , $I_{\text{F}}=1200\text{mA}$ Test board: See NOTES below	1000h	#1	0/22
高温高湿老化 Temperature Humidity Operating		$85^{\circ}\text{C}$ , RH=85%, $I_{\text{F}}=1200\text{mA}$ Test board: See NOTES below	1000h	#1	0/22

### b) 失效判定 Failure Criteria

判定 Criteria #	项目 Items	条件 Conditions	失效判定 Failure Criteria
#1	正向电压 Forward Voltage ( $V_{\text{F}}$ )	$I_{\text{F}}$	$>$ 初始值 $\times 1.1$ 倍 $>$ Initial value $\times 1.1$
	光通量 Luminous Flux ( $\Phi_{\text{v}}$ )	$I_{\text{F}}$	$<$ 初始值 $\times 0.7$ 倍 $<$ Initial value $\times 0.7$
	反向电流 Reverse Current ( $I_{\text{R}}$ )	$V_{\text{R}}=5\text{V}$	$>$ 1 $\mu\text{A}$ $>$ 1 $\mu\text{A}$
#2	回流焊 Solderability	-	焊接面积 $<$ 80% Less than 80% solder coverage

## 11、注意事项 Cautions

### a) 存储 Storage

- 不要将芯片放在潮湿的地方，存放温度在 5℃~30℃之间，相对湿度在 30% 以下。  
Do not place the chips in damp places, Storage temperature between 5 °C and 30 °C, Relative humidity under 30%.
- 开包后建议在 24 小时内过完回流焊，车间条件 ≤30℃/60%RH。  
After opening the package, it is recommended to finish the reflow within 24 hours. The workshop conditions are ≤30°C/60%RH
- 如果受潮，需将贴片卷盘放入 60℃烤箱烘烤 24 小时；打开后，LED 灯可重新密封在原始真空袋中。  
If it is wet, the patch reel should be baked in a 60 ° C oven for 24 hours; after opening, the LED light can be resealed in the original vacuum bag.
- 不要接触任何未知的液体，特别是丙酮。  
Don't touch any unknown liquid, In particular, acetone.
- 防止静电死亡，手动操作需要戴橡胶手套并佩戴静电环。  
Prevent electrostatic killed, Manual operation is required to wear rubber gloves and wear electrostatic ring.

### b) 清洗 Cleaning

- 通常，LED 不建议对部件进行湿式清洁处理，因为封装不是密封的。  
In general, LED does not recommend a wet cleaning process for component as the package is not hermetically sealed.
- 由于采用开放式设计，所有类型的清洁液都可能渗透到封装中，导致 LED 退化或完全失效。  
Due to the open design, all kind of cleaning liquids can infiltrate the package and cause a degradation or a complete failure of the LED.

### c) 操作注意 Handling Precautions



- 在处理过程中，还应注意确保组件顶面没有压力  
During the handling, care should be taken as well to ensure no pressure on the top surface of component.
- 应避免使用所有类型的尖锐物体（例如镊子，指甲等），以防止对硅树脂造成压力，因为这会导致部件损坏。  
All types of sharp objects(e.g. forceps, fingernail, etc) should be avoided in order to prevent stress to the silicone, since this can lead to damage of the component.





## 12、 文件履历表 Document Resume

序号	变更日期	变更人	版本	变更内容
1	2020-7-9	王宝	A00	新版发行
2				
3				
4				
5				

LatticePower Semiconductor